

# BETU BRACKET SEVENTY

LIGHT AND DESIGN 2023



VIVIDA  
INTERNATIONAL



BETU  
0057.12 WN  
PAG 4-5



BETU  
0057.10 WN  
PAG 6-7



BETU  
0057.11 WN  
PAG 8



BRACKET  
0037.50.SA WN  
PAG 10-11



BRACKET  
0037.50.BI W  
0037.50.BI N  
PAG 12-13



BRACKET  
0037.50.NE W  
PAG 14



SEVENTY  
0080.10.BRL  
PAG 16-17



SEVENTY1  
0080.30.BRL  
PAG 18-19



SEVENTY4  
0080.31.BRL  
PAG 20-21





# BETU

LAMPADA A PARETE WALL LAMP



**0057.12 WN**

**SABBIA  
SAND**

KELVIN  
COLOUR TEMPERATURE  
**3.000 K - 4.000 K**

LUMEN  
**3.000 K - 40 lm  
4.000 K - 50 lm**

VATTAGGIO  
WATTAGE  
**2 W**

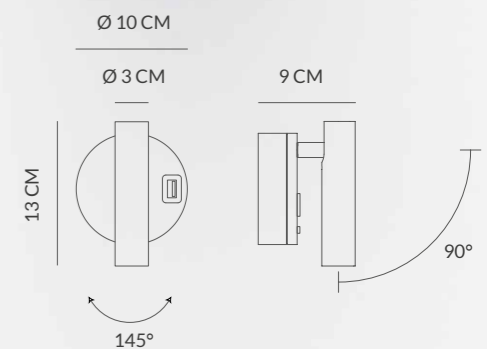

# BETU

LAMPADA A PARETE WALL LAMP



## 0057.10 WN

BIANCO  
SAND WHITE

KELVIN  
COLOUR TEMPERATURE  
3.000 K - 4.000 K

LUMEN  
3.000 K - 40 lm  
4.000 K - 50 lm

VATTAGGIO  
WATTAGE  
2 W

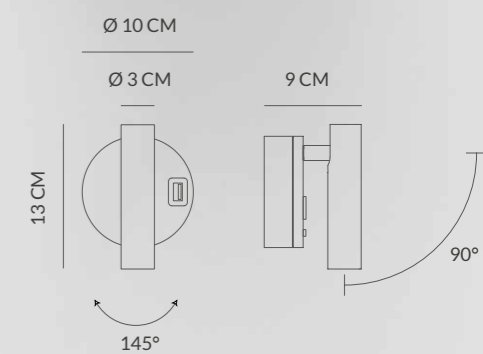





# BETU BIANCO / WHITE

LAMPADA A PARETE WALL LAMP

**0057.10 WN**  
 CODICE EAN 8057506773756  
 BIANCO / WHITE

KELVIN  
 COLOUR TEMPERATURE  
**3.000 K - 4.000 K**

LUMEN  
**3.000 K - 40 lm**  
**4.000 K - 50 lm**

VATTAGGIO  
 WATTAGE  
**2 W**

**NON DIMMERABILE**  
**NOT DIMMABLE**

GRADO DI PROTEZIONE  
 IP RATING  
**IP 20**

MATERIALE  
 MATERIAL  
**ALLUMINIO**  
**ALUMINIUM**

ANGOLO  
 BEAM ANGLE  
**15°**

CRI  
**80**

FATTORE DI POTENZA  
 POWER FACTOR  
**> 0.5**

**DRIVER INCLUSO**  
**DRIVER INCLUDED**

DURATA ORE  
 LIFETIME HOURS  
**50.000 H**



VOLTAGGIO  
 VOLTAGE  
**100 - 240V**

FREQUENZA  
 OPERATING FREQUENCY  
**50/60 Hz**

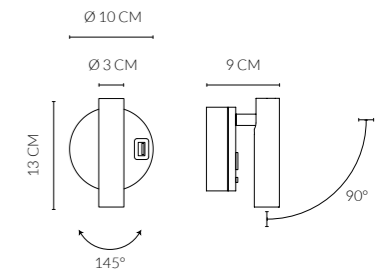

# BETU NERO / BLACK

LAMPADA A PARETE WALL LAMP

**0057.11 WN**  
 CODICE EAN 8057506773763  
 NERO / BLACK

KELVIN  
 COLOUR TEMPERATURE  
**3.000 K - 4.000 K**

LUMEN  
**3.000 K - 40 lm**  
**4.000 K - 50 lm**

VATTAGGIO  
 WATTAGE  
**2 W**

**NON DIMMERABILE**  
**NOT DIMMABLE**

GRADO DI PROTEZIONE  
 IP RATING  
**IP 20**

MATERIALE  
 MATERIAL  
**ALLUMINIO**  
**ALUMINIUM**

ANGOLO  
 BEAM ANGLE  
**15°**

CRI  
**80**

FATTORE DI POTENZA  
 POWER FACTOR  
**> 0.5**

**DRIVER INCLUSO**  
**DRIVER INCLUDED**

DURATA ORE  
 LIFETIME HOURS  
**50.000 H**



VOLTAGGIO  
 VOLTAGE  
**100 - 240V**

FREQUENZA  
 OPERATING FREQUENCY  
**50/60 Hz**

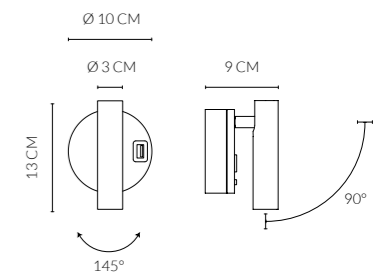

# BETU SABBIA / SAND

LAMPADA A PARETE WALL LAMP

**0057.12 WN**  
 CODICE EAN 8057506773770  
 SABBIA / SAND

KELVIN  
 COLOUR TEMPERATURE  
**3.000 K - 4.000 K**

LUMEN  
**3.000 K - 40 lm**  
**4.000 K - 50 lm**

VATTAGGIO  
 WATTAGE  
**2 W**

**NON DIMMERABILE**  
**NOT DIMMABLE**

GRADO DI PROTEZIONE  
 IP RATING  
**IP 20**

MATERIALE  
 MATERIAL  
**ALLUMINIO**  
**ALUMINIUM**

ANGOLO  
 BEAM ANGLE  
**15°**

CRI  
**80**

FATTORE DI POTENZA  
 POWER FACTOR  
**> 0.5**

**DRIVER INCLUSO**  
**DRIVER INCLUDED**

DURATA ORE  
 LIFETIME HOURS  
**50.000 H**



VOLTAGGIO  
 VOLTAGE  
**100 - 240V**

FREQUENZA  
 OPERATING FREQUENCY  
**50/60 Hz**

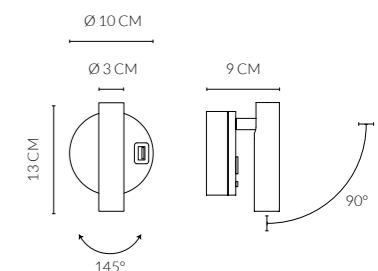

**0057.11 WN**  
 NERO  
 BLACK

KELVIN  
 COLOUR TEMPERATURE  
**3.000 K - 4.000 K**

LUMEN  
**3.000 K - 40 lm**  
**4.000 K - 50 lm**

VATTAGGIO  
 WATTAGE  
**2 W**



# BRACKET

LAMPADA DA TERRA FLOOR LAMP



**0037.50.SA WN**

**SABBIA  
SAND**

KELVIN  
COLOUR TEMPERATURE  
**3.000 K - 4.000 K**

LUMEN  
**3.000 K - 1980 lm**  
**4.000 K - 2138 lm**

VATTAGGIO  
WATTAGE  
**33 W**

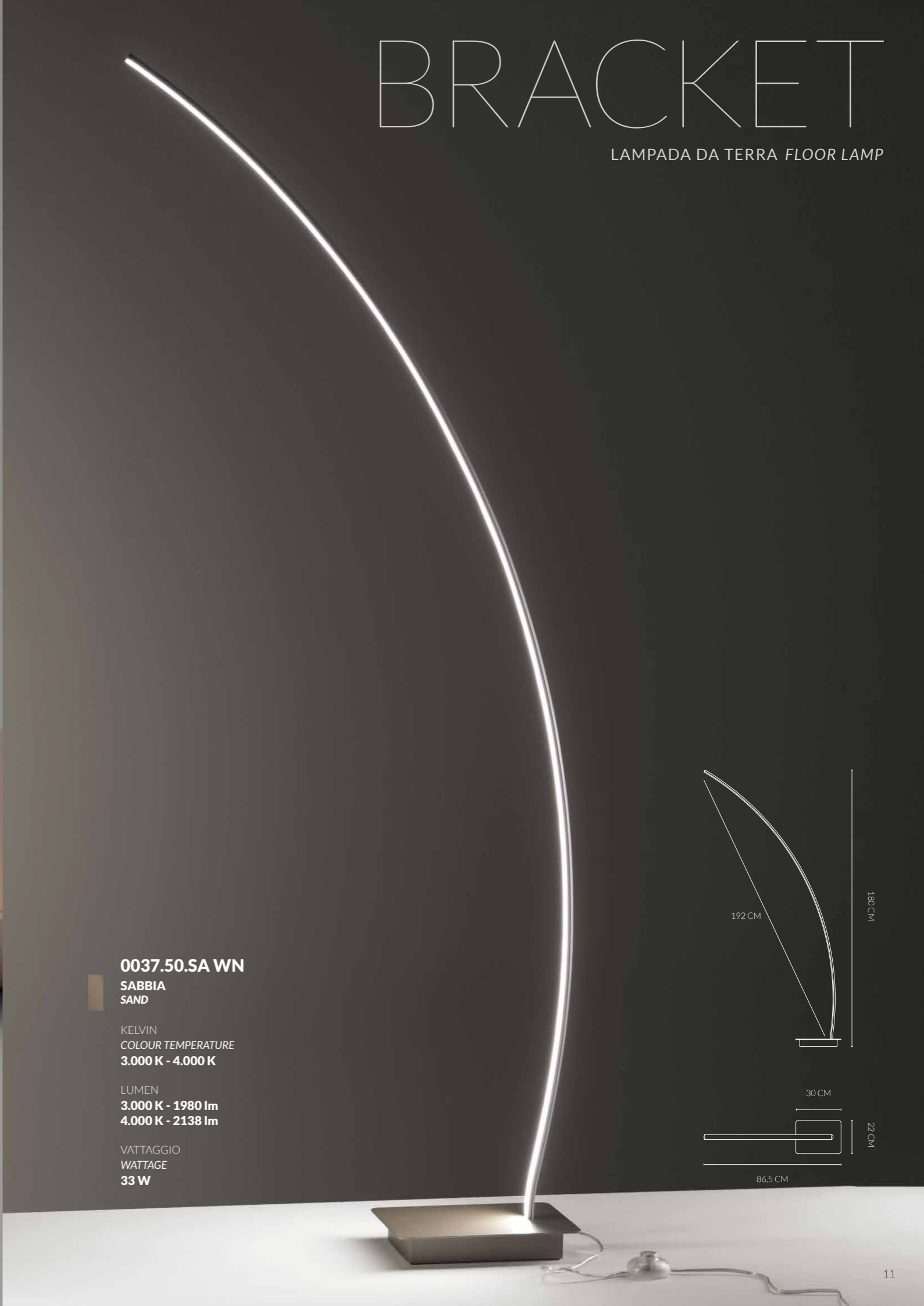

# BRACKET

LAMPADA DA TERRA FLOOR LAMP



**0037.50.BI W**  
**BIANCO**  
**WHITE**

KELVIN  
COLOUR TEMPERATURE  
**3.000 K**

LUMEN  
**1.980 lm**

VATTAGGIO  
WATTAGE  
**33 W**

**0037.50.BI N**  
**BIANCO**  
**WHITE**

KELVIN  
COLOUR TEMPERATURE  
**4.000 K**

LUMEN  
**2.138 lm**

VATTAGGIO  
WATTAGE  
**33 W**





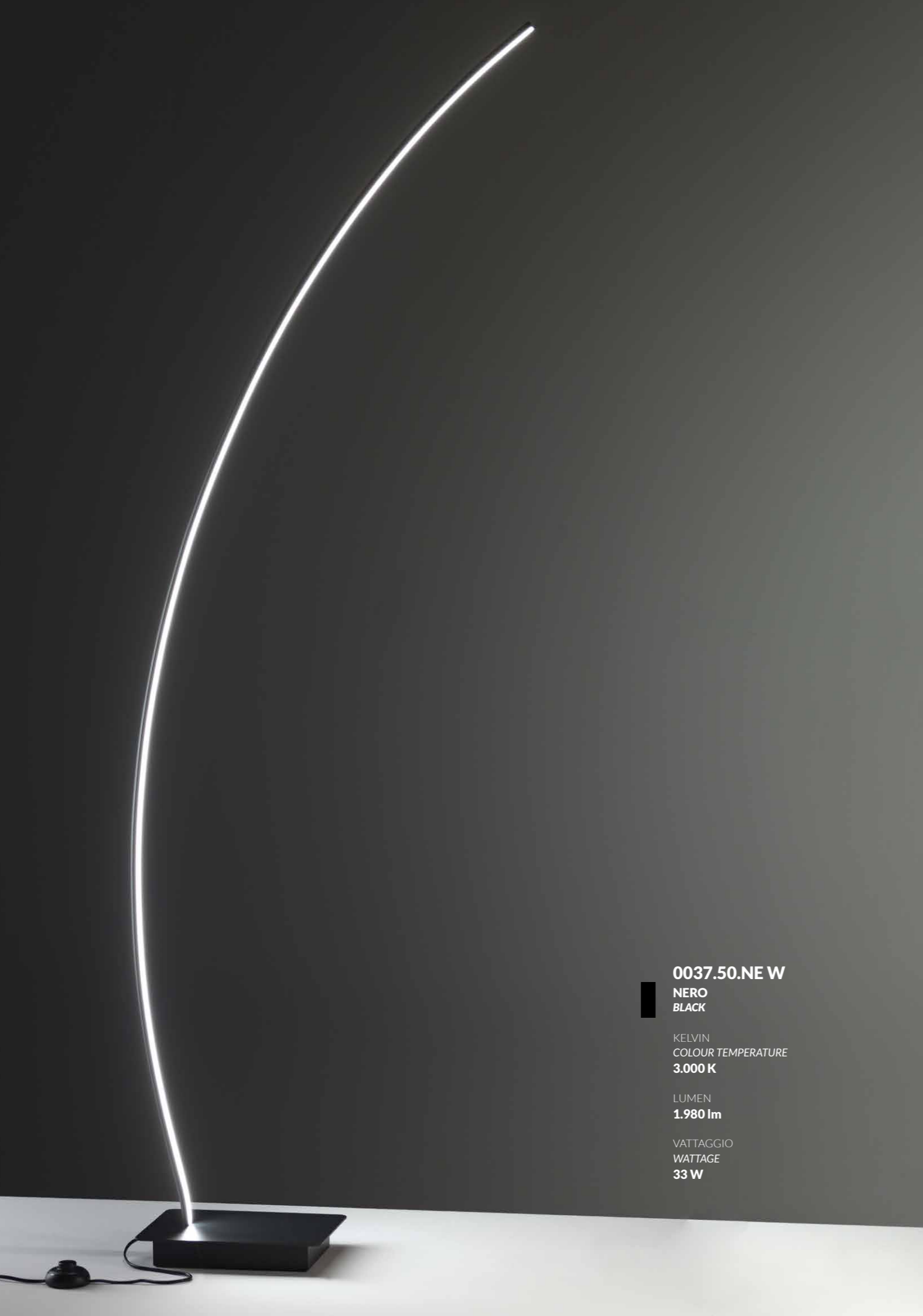

**0037.50.NE W**

**NERO  
BLACK**

KELVIN  
COLOUR TEMPERATURE  
**3.000 K**

LUMEN  
**1.980 lm**

VATTAGGIO  
WATTAGE  
**33 W**

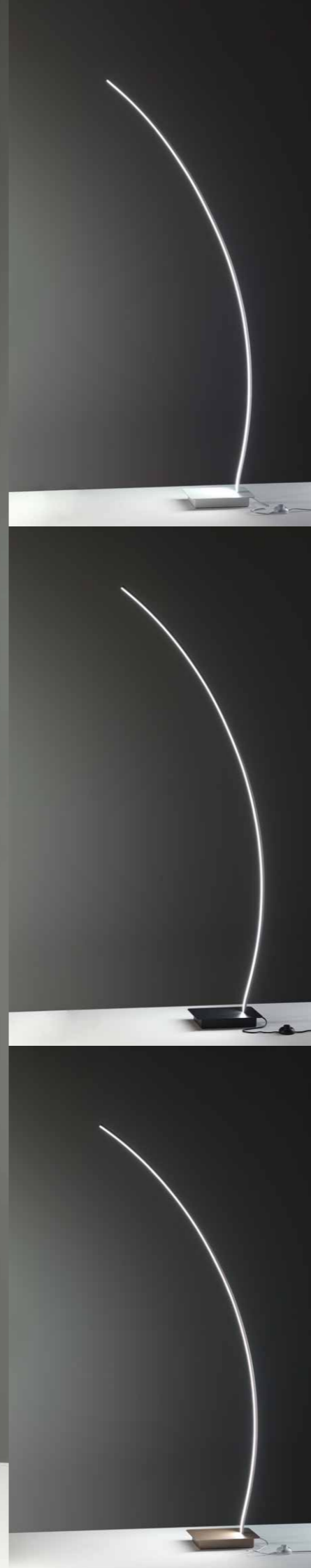

# BRACKET BIANCO / WHITE

LAMPADA DA TERRA FLOOR LAMP

**0037.50.BI W**  
CODICE EAN 8058776895506  
**BIANCO / WHITE**

**0037.50.BI N**  
CODICE EAN 8058776898910  
**BIANCO / WHITE**

KELVIN W  
COLOUR TEMPERATURE  
**3.000 K**

KELVIN N  
COLOUR TEMPERATURE  
**4.000 K**

ANGOLO  
BEAM ANGLE  
**120°**

VATTAGGIO  
VOLTAGE  
**220-240V**

LUMEN W  
**1.980 lm**

LUMEN N  
**2.138 lm**

CRI  
**80**

FREQUENZA  
OPERATING FREQUENCY  
**50/60 Hz**

VATTAGGIO  
WATTAGE  
**33 W**

FATTORE DI POTENZA  
POWER FACTOR  
**> 0.9**

**NON DIMMERABILE  
NOT DIMMABLE**

**DRIVER INCLUSO  
DRIVER INCLUDED**

GRADO DI PROTEZIONE  
IP RATING  
**IP 20**

DURATA ORE  
LIFETIME HOURS  
**50.000 H**

MATERIALE  
MATERIAL  
**ALLUMINIO + SILICONE  
ALUMINIUM + SILICONE**

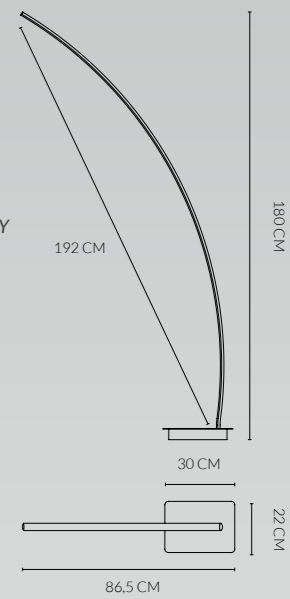

# BRACKET NERO / BLACK

LAMPADA DA TERRA FLOOR LAMP

**0037.50.NE W**  
CODICE EAN 8059606142227  
**NERO / BLACK**

KELVIN  
COLOUR TEMPERATURE  
**3.000 K**

ANGOLO  
BEAM ANGLE  
**120°**

VATTAGGIO  
VOLTAGE  
**220-240V**

LUMEN  
**1.980 lm**

CRI  
**80**

FREQUENZA  
OPERATING FREQUENCY  
**50/60 Hz**

VATTAGGIO  
WATTAGE  
**33 W**

FATTORE DI POTENZA  
POWER FACTOR  
**> 0.9**

**NON DIMMERABILE  
NOT DIMMABLE**

**DRIVER INCLUSO  
DRIVER INCLUDED**

GRADO DI PROTEZIONE  
IP RATING  
**IP 20**

DURATA ORE  
LIFETIME HOURS  
**50.000 H**

MATERIALE  
MATERIAL  
**ALLUMINIO + SILICONE  
ALUMINIUM + SILICONE**

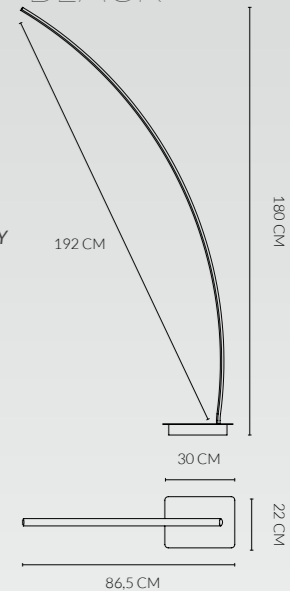

# BRACKET SABBIA / SAND

LAMPADA DA TERRA FLOOR LAMP

**0037.50.SA WN**  
CODICE EAN 8057506773534  
**SABBIA / SAND**

KELVIN  
COLOUR TEMPERATURE  
**3.000 K - 4.000 K**

ANGOLO  
BEAM ANGLE  
**120°**

VATTAGGIO  
VOLTAGE  
**220-240V**

LUMEN  
**3.000 K - 1.980 lm  
4.000 K - 2.138 lm**

CRI  
**80**

FREQUENZA  
OPERATING FREQUENCY  
**50/60 Hz**

VATTAGGIO  
WATTAGE  
**33 W**

FATTORE DI POTENZA  
POWER FACTOR  
**> 0.9**

**NON DIMMERABILE  
NOT DIMMABLE**

**DRIVER INCLUSO  
DRIVER INCLUDED**

GRADO DI PROTEZIONE  
IP RATING  
**IP 20**

DURATA ORE  
LIFETIME HOURS  
**50.000 H**

MATERIALE  
MATERIAL  
**ALLUMINIO + SILICONE  
ALUMINIUM + SILICONE**

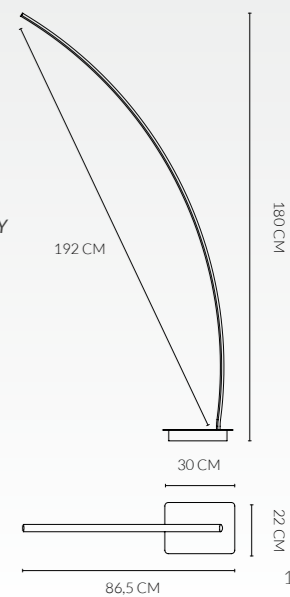



# SEVENTY

LAMPADA A PARETE WALL LAMP



**0080.10.BRL**  
**MARRONE OSSIDATO**  
**OXIDIZED BROWN**

KELVIN  
COLOUR TEMPERATURE  
**3.000 K**

LUMEN  
**660 lm**

VATTAGGIO  
WATTAGE  
**1x2W+1x4W**

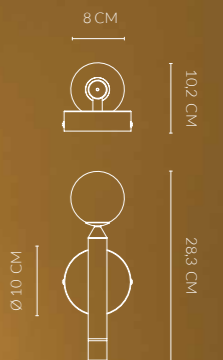

# SEVENTY 1

SOSPENSIONE PENDANT LAMP



**0080.30.BRL**  
**MARRONE OSSIDATO**  
**OXIDIZED BROWN**

KELVIN  
COLOUR TEMPERATURE  
**3.000 K**

LUMEN  
**660 lm**

VATTAGGIO  
WATTAGE  
**1x2W+1x4W**



# SEVENTY 4

SOSPENSIONE PENDANT LAMP



**0080.31.BRL**  
MARRONE OSSIDATO  
OXIDIZED BROWN

KELVIN  
COLOUR TEMPERATURE  
**3.000 K**

LUMEN  
**2.640 lm**

VATTAGGIO  
WATTAGE  
**4 x 2 W + 4 x 4 W**

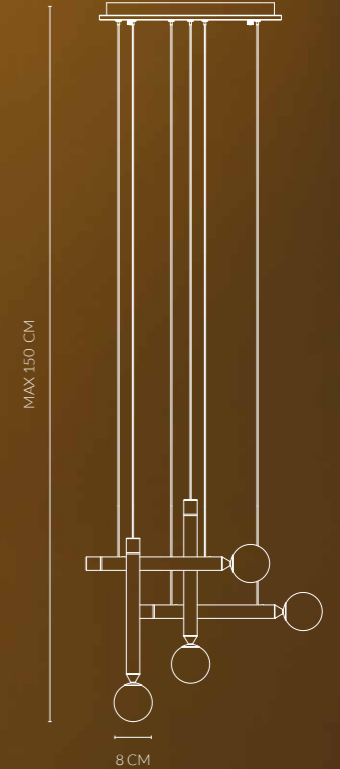
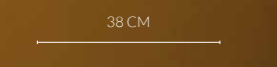
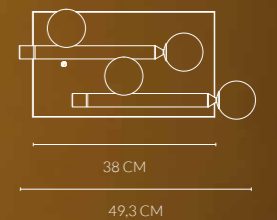





# SEVENTY

LAMPADA A PARETE WALL LAMP

**0080.10.BRL**  
 CODICE EAN 8057506774135  
 MARRONE OSSIDATO / OXIDIZED BROWN

KELVIN  
 COLOUR TEMPERATURE  
**3.000 K**

ANGOLO  
 BEAM ANGLE  
**260°**

VOLTAGGIO  
 VOLTAGE  
**220 - 240**

LUMEN  
**660 lm**

CRI  
**80**

FREQUENZA  
 OPERATING FREQUENCY  
**50/60 Hz**

VATTAGGIO  
 WATTAGE  
**1 x 2 W + 1 x 4 W**

FATTORE DI POTENZA  
 POWER FACTOR  
**> 0.5**

**NON DIMMERABILE**  
**NOT DIMMABLE**

**DRIVER INCLUSO**  
**DRIVER INCLUDED**

GRADO DI PROTEZIONE  
 IP RATING  
**IP 20**

DURATA ORE  
 LIFETIME HOURS  
**17.520 H**

MATERIALE  
 MATERIAL  
**ALLUMINIO + ACRILICO + VETRO**  
**ALUMINIUM + ACRYLIC + GLASS**

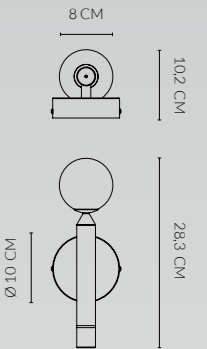

# SEVENTY 1

SOSPENSIONE PENDANT LAMP

**0080.30.BRL**  
 CODICE EAN 8059606140339  
 MARRONE OSSIDATO / OXIDIZED BROWN

KELVIN  
 COLOUR TEMPERATURE  
**3.000 K**

ANGOLO  
 BEAM ANGLE  
**260°**

VOLTAGGIO  
 VOLTAGE  
**220 - 240**

LUMEN  
**660 lm**

CRI  
**80**

FREQUENZA  
 OPERATING FREQUENCY  
**50/60 Hz**

VATTAGGIO  
 WATTAGE  
**1 x 2 W + 1 x 4 W**

FATTORE DI POTENZA  
 POWER FACTOR  
**> 0.5**

**NON DIMMERABILE**  
**NOT DIMMABLE**

**DRIVER INCLUSO**  
**DRIVER INCLUDED**

GRADO DI PROTEZIONE  
 IP RATING  
**IP 20**

DURATA ORE  
 LIFETIME HOURS  
**17.520 H**

MATERIALE  
 MATERIAL  
**ALLUMINIO + ACRILICO + VETRO**  
**ALUMINIUM + ACRYLIC + GLASS**

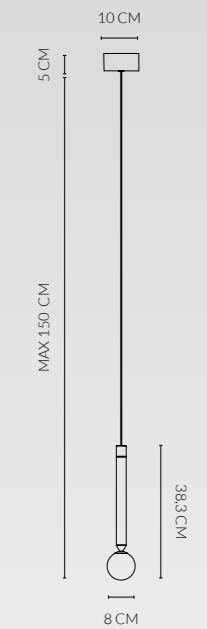

# SEVENTY 4

SOSPENSIONE PENDANT LAMP

**0080.31.BRL**  
 CODICE EAN 8059606140346  
 MARRONE OSSIDATO / OXIDIZED BROWN

KELVIN  
 COLOUR TEMPERATURE  
**3.000 K**

ANGOLO  
 BEAM ANGLE  
**360°**

VOLTAGGIO  
 VOLTAGE  
**220 - 240**

LUMEN  
**2.640 lm**

CRI  
**80**

FREQUENZA  
 OPERATING FREQUENCY  
**50/60 Hz**

VATTAGGIO  
 WATTAGE  
**4 x 2 W + 4 x 4 W**

FATTORE DI POTENZA  
 POWER FACTOR  
**> 0.9**

**NON DIMMERABILE**  
**NOT DIMMABLE**

**DRIVER INCLUSO**  
**DRIVER INCLUDED**

GRADO DI PROTEZIONE  
 IP RATING  
**IP 20**

DURATA ORE  
 LIFETIME HOURS  
**17.520 H**

MATERIALE  
 MATERIAL  
**ALLUMINIO + ACRILICO + VETRO**  
**ALUMINIUM + ACRYLIC + GLASS**

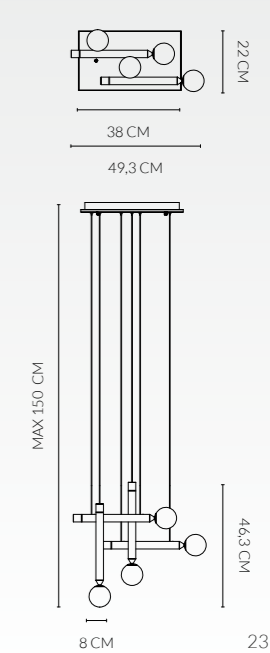



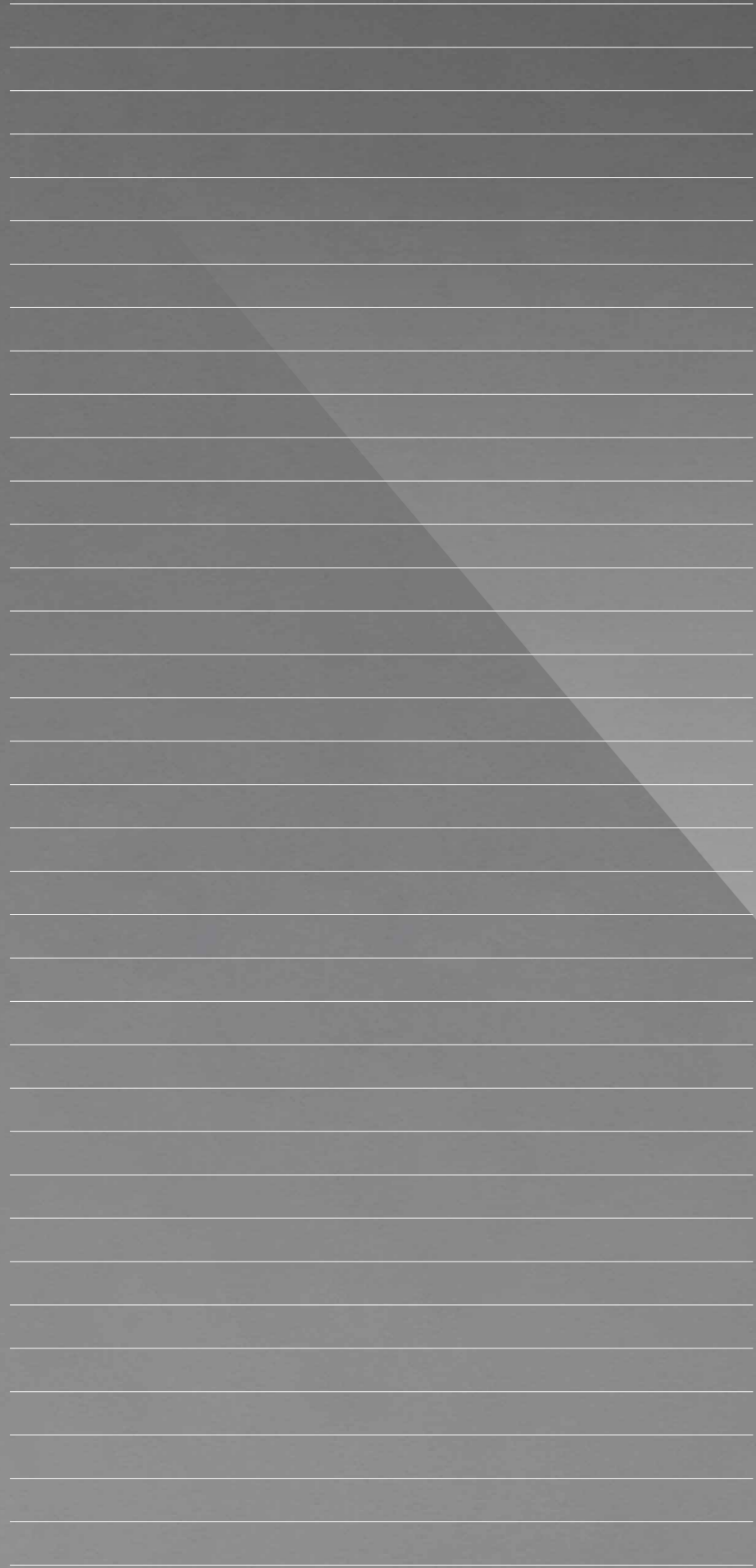

Concept & Graphic Design  
Zuzanna Niespor

STUDIO  
ZUZANNA  
NIESPOR

Materiale pubblicitario non destinato alla vendita  
stampato nel mese di dicembre 2022





**VIVIDA**  
INTERNATIONAL

**VIVIDA INTERNATIONAL SRL**  
Società a Socio Unico

VIA TURA DAL FIUME, 7  
47892 GUALDICCIOLO  
REP. SAN MARINO  
COE SM 26498

T +378 0549 911 438

INFO@VIVIDAINTERNATIONAL.SM  
VIVIDAINTERNATIONAL.SM