

LOGICA

Catalogo Generale
2021

INDICE VISIVO

STREAMLIGHT SYSTEM



Streamlight
System
12



Streamlight
22



Clara
26

MAGNETIC SYSTEM



Klik Klak
32

TRACK SPOTLIGHTS



Fulgor
50



Unico
Compact
54



Unico Dicro
60

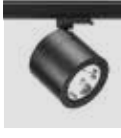

Unico AR111
64



Orbit
68



Track_Cover
70

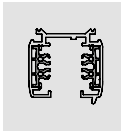

Tracks
Tracks incasso
78



Emergenza
83

DOWNLIGHTS



Deep_EVO
86



Deep_EVO
LESS
94



Deep_EVO
STD
98

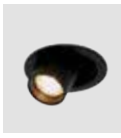

Fulgor_IN
100



Gymbo
Quadro
104



Gymbo
Tondo
108

DOWNLIGHTS



Punto
110



Occhio
116



Hyper Dicro
+ Blitz
118



Radiante
122



Biluce
128



Mini
132



Zeus
140



Aqua_COB
142



Aqua_SMD
144



Frame
146



Frame 111
149



Frameless
152

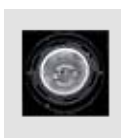

Frameless 111
155



Wizard
158



Deep c/vetro
165



Deep zero
166



Deep
167



Deep 111 zero
168



Deep 111
169

RECHARGEABLE



Diogene
Hybrid
176











Diogene
180





Twiggy_LESS
188





CEILING LIGHTS

	Altair 194		Cyl 200		Container 204
	Container 111 208		Box Dicro 212		Box AR111 213
	Unico Dicro 214		Orbit 216		

SUSPENSION LIGHTS

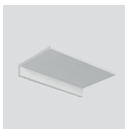
	Cyl Sosp 220		Shanghai 224
--	-----------------	--	-----------------

WALL LIGHTS

	Minima 230		Aurora 238		Dumbo 242
	Bloc 246				

PROFILES

	Wall incasso 252		Onda incasso 254		Line_EVO 258
---	---------------------	---	---------------------	---	-----------------

PROFILES

	Line DEEP incasso 262		Line incasso 264		Double 266
	PR1 268		PR1_DEEP 270		PR2 incasso 272
	PR2_DEEP incasso 274		PR3_EVO 276		PR4 280

OUTDOOR

	Titano EVO 288		Moonlight 296		Fos 302
	Combi EVO 306		Accento 310		Dardo 312
	Scorpio 318				

DRIVER

	Driver 324
---	---------------

LOGICA

LIGHTING DESIGN

Logica è un brand di illuminazione che ricerca la semplicità e minimalità delle forme, eliminando tutto ciò che è superfluo. Così tu puoi vivere la luce senza inutili distrazioni. Dal 1999 operiamo nel settore illuminotecnico e architettonico.

Qualità. Materiali, processi e tecnologie di qualità sono alla base di ogni prodotto. È nella cura e precisione di quello che c'è dentro all'oggetto che si distingue ciò che ha valore da ciò che è soltanto un bell'oggetto. Vogliamo che i nostri prodotti siano longevi, per questo scegliamo ogni elemento con attenzione.

Ricerca. La ricerca è il primo importante step per il design dei nostri apparecchi. Ci assicuriamo di elaborare progetti e trovare prodotti che rispondano ai bisogni dei nostri clienti e che si distinguano per la loro efficienza ed estetica funzionale.

Sostenibilità. Crediamo sia di fondamentale importanza nella nostra epoca avere attenzione per tutti gli aspetti riguardanti il rispetto per il pianeta che abitiamo. Ci impegniamo per ridurre il nostro impatto ambientale, scegliendo tecnologie e processi che ci permettano di essere più sostenibili.

Dinamicità. Ci piace metterci in discussione, essere continuamente in movimento e aggiornati con i nuovi bisogni e tecnologie. Indaghiamo le richieste del mercato e le nuove tendenze, facendole nostre e rielaborandole. Così, rimaniamo fedeli ai nostri valori, ma non abbiamo paura di sperimentare spingendoci al di là della nostra zona di comfort.

Logica is a lighting brand which searches for simplicity and minimalism in design, removing all that is superfluous; so you can live the light without useless distractions. We have been operating in the Technical and Architectural Lighting business since 1999.

Quality. Quality materials, efficient processes and advanced technologies are the cornerstones of every product. It's from the care and precision of what is within the object that you distinguish what is valuable as a whole. We want our products to be long-lasting and that's exactly why we select each part with the utmost care.

Research. Research is the first important step in designing our fittings. We develop and source products which meet our customers' requirements and that distinguish themselves for their aesthetic and efficient functionality.

Sustainability. We strongly believe it's absolutely important to pay attention to all aspects concerning the planet we live in. That's why we make sure that the decisions we take have a low environmental impact, by choosing technologies and processes which comply with a sustainable approach.

Dynamism. We like questioning ourselves, being continuously on the move and keeping abreast of the new needs and technologies. We keep a close eye on what the market requires and its new trends absorbing them without being subdued by them. By doing so we are faithful to our values, but at the same time we are not afraid of pushing ourselves beyond our comfort zone.

Varietà. I prodotti del brand sono pensati per coprire un vasto ventaglio di necessità, in modo che ogni problema possa trovare soluzione. Una varietà ricca, mai banale.

Dettagli. Riconosciamo fondamentale la cura e la precisione di tutti gli elementi che ruotano attorno ai prodotti che offriamo. Facciamo la differenza grazie all'attenzione ai piccoli dettagli, in fase di progettazione, di produzione e di vendita.

Variety. Our products are conceived to cover a wide range of requirements so that any problem can be solved with. A rich variety never banal or forced.

Details. We deem absolutely fundamental the attention and scrutiny of all elements involved in the products we offer. We make a difference thanks to our focus on small details during the designing process, production and sales.



STREAMLIGHT SYSTEM

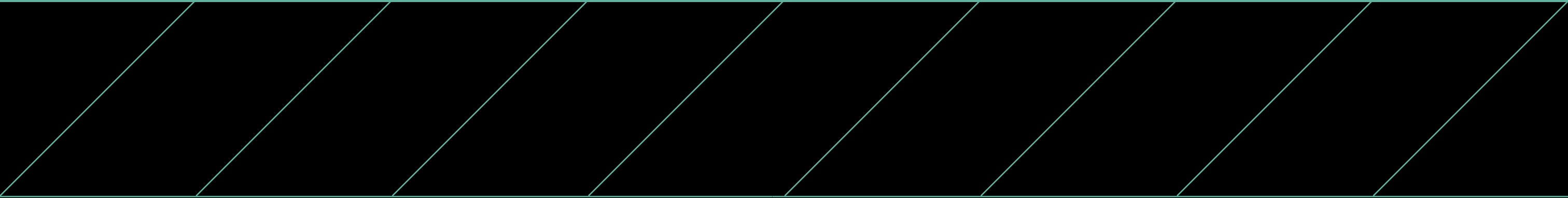



Streamlight System sospensione/Suspension



Clara

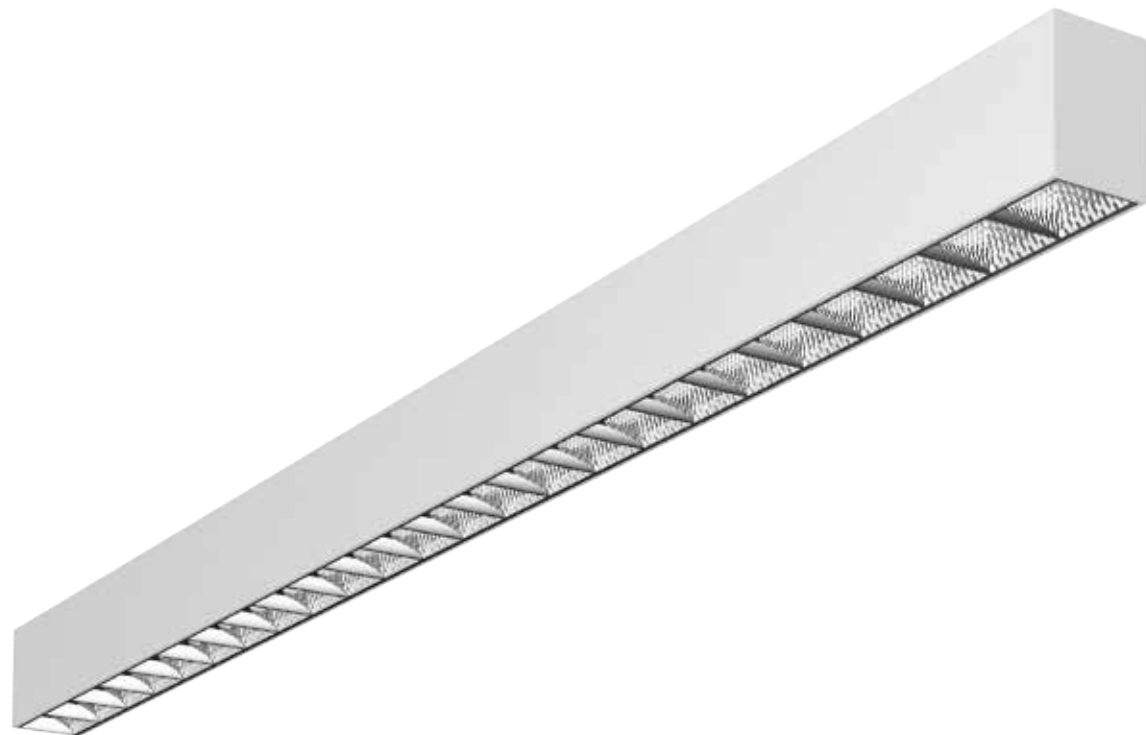

STREAMLIGHT SYSTEM

Profilo LED integrato bi-emissione
in alluminio estruso
Ottiche anti-glare UGR<19 per luce diretta
e schermo in PC per luce indiretta
Driver integrato. Versioni ON/OFF, 1-10V o Dali

Extruded aluminium profile equipped with
integrated LED for direct and indirect lighting
Anti-glare UGR<19 optical reflectors for direct
lighting and PC diffuser for indirect lighting
Integrated Driver. ON/OFF, 1-10V or DALI version

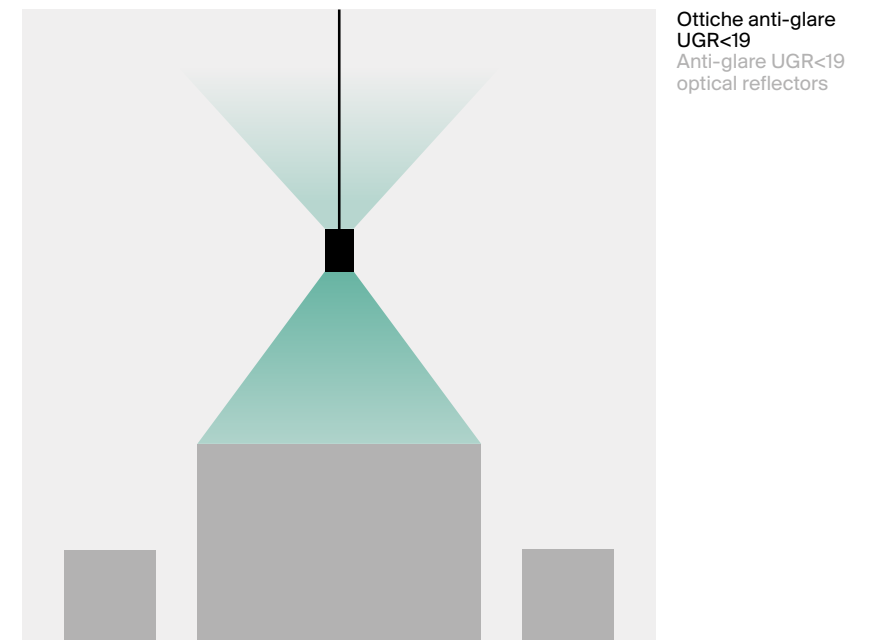
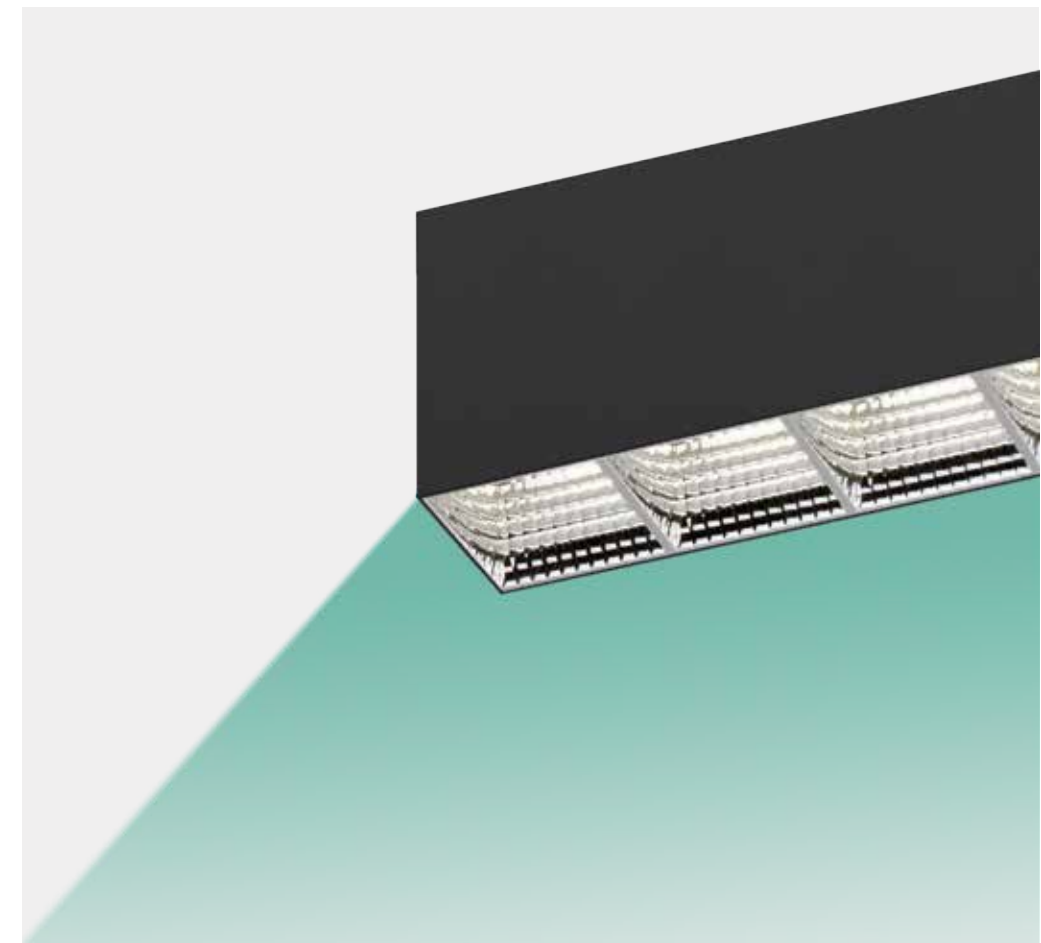

Ottiche anti-glare
UGR<19
Anti-glare UGR<19
optical reflectors

COMFORT VISIVO

L'elemento riflettente di Streamlight System è costruito in modo tale da evitare fastidiosi riflessi. Se associato all'opzione con luce indiretta, permette di ridurre lo sforzo visivo ed ottenere un benessere indispensabile all'ambiente di lavoro.

VISUAL COMFORT

Streamlight reflector is designed to prevent unpleasant glaring effects. If suspended and combined with indirect lighting, it reduces eyestrain and ensures a general visual comfort which is indispensable in the workplace.

CONFIGURAZIONI
CONFIGURATIONS

INSTALLAZIONE
APPLICATION

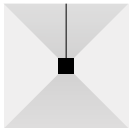

Sospensione
diretta-indiretta
Suspension
direct-indirect

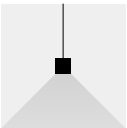

Sospensione
Suspension



Soffitto
Ceiling

FINITURA
FINISHING



Bianco
White



Nero
Black

RACCORDI
JUNCTIONS



Giunto lineare
Linear
connector



Giunto "L"
"L" connector

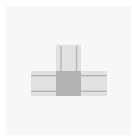

Giunto "T"
"T" connector

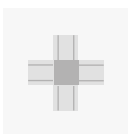

Giunto "X"
"X" connector

DRIVER



ON/OFF



Dimm. 1-10V



DALI



Streamlight System Soffitto
Streamlight System Ceiling

2x Attacco a soffitto/Ceiling bracket



Streamlight System Sospensione con luce diretta-indiretta
Streamlight System suspension with direct-indirect lighting

2x Sospensione e rosone 2 mt (1 pz) /
Suspension and canopy 2 mt (1 pc)





STREAMLIGHT SYSTEM

LED
CRI >82
PF 0.9

INSTALLAZIONE APPLICATION

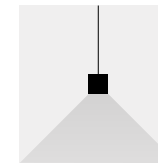

Sospensione/
Suspension

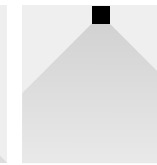

Soffitto/Ceiling

DISEGNI TECNICI TECHNICAL DRAWINGS

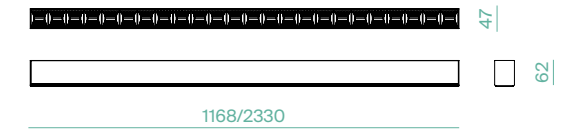

CODE	FINISHING	WATT	LUMEN	BEAM	KELVIN	DRIVER
42654	Bianco/White	27W+3W	2700+300	85°*85°	3000K	ON-OFF 36V-750mA
42655	Nero/Black	27W+3W	2700+300	85°*85°	3000K	ON-OFF 36V-750mA
42656	Bianco/White	27W+3W	2700+300	85°*85°	4000K	ON-OFF 36V-750mA
42657	Nero/Black	27W+3W	2700+300	85°*85°	4000K	ON-OFF 36V-750mA
42662	Bianco/White	41W+4W	4500+500	85°*85°	3000K	ON-OFF 36V-1250mA
42663	Nero/Black	41W+4W	4500+500	85°*85°	3000K	ON-OFF 36V-1250mA
42664	Bianco/White	41W+4W	4500+500	85°*85°	4000K	ON-OFF 36V-1250mA
42665	Nero/Black	41W+4W	4500+500	85°*85°	4000K	ON-OFF 36V-1250mA
42776	Bianco/White	27W+3W	2700+300	85°*85°	3000K	1-10V 36V-750mA
42777	Nero/Black	27W+3W	2700+300	85°*85°	3000K	1-10V 36V-750mA
42778	Bianco/White	27W+3W	2700+300	85°*85°	4000K	1-10V 36V-750mA
42779	Nero/Black	27W+3W	2700+300	85°*85°	4000K	1-10V 36V-750mA
42780	Bianco/White	41W+4W	4500+500	85°*85°	3000K	1-10V 36V-1250mA
42781	Nero/Black	41W+4W	4500+500	85°*85°	3000K	1-10V 36V-1250mA
42782	Bianco/White	41W+4W	4500+500	85°*85°	4000K	1-10V 36V-1250mA
42783	Nero/Black	41W+4W	4500+500	85°*85°	4000K	1-10V 36V-1250mA
42658	Bianco/White	27W+3W	2700+300	85°*85°	3000K	DALI 36V-750mA
42659	Nero/Black	27W+3W	2700+300	85°*85°	3000K	DALI 36V-750mA
42660	Bianco/White	27W+3W	2700+300	85°*85°	4000K	DALI 36V-750mA
42661	Nero/Black	27W+3W	2700+300	85°*85°	4000K	DALI 36V-750mA
42666	Bianco/White	41W+4W	4500+500	85°*85°	3000K	DALI 36V-1250mA
42667	Nero/Black	41W+4W	4500+500	85°*85°	3000K	DALI 36V-1250mA
42668	Bianco/White	41W+4W	4500+500	85°*85°	4000K	DALI 36V-1250mA
42669	Nero/Black	41W+4W	4500+500	85°*85°	4000K	DALI 36V-1250mA



ACCESSORI ACCESSORIES



42672

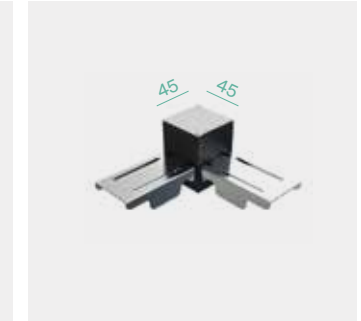

42673 - 42674

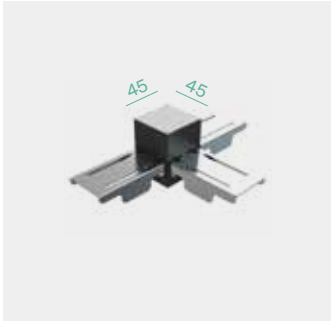

42677 - 42678



42675 - 42676

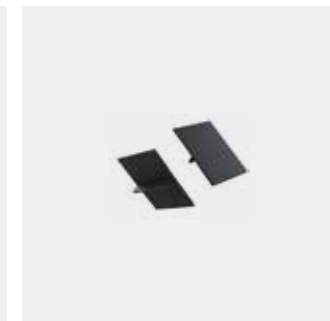

42679 - 42680



42681 - 42682 - 42685



42728

CODE	FINISHING	DESCRIPTION
42672	Alluminio/Aluminium	Congiunzione Lineare /Linear Connector
42673	Nero / Black	Giunto "L"/"L"-Connector
42674	Bianco / White	Giunto "L"/"L"-Connector
42675	Nero / Black	Giunto "X"/"X"-Connector
42676	Bianco / White	Giunto "X"/"X"-Connector
42677	Nero / Black	Giunto "T"/"T"-Connector
42678	Bianco / White	Giunto "T"/"T"-Connector
42679	Nero / Black	Testate (2 Pcs.)/End-Caps
42680	Bianco / White	Testate (2 Pcs.)/End-Caps
42681	n/a	Sospensione acciaio 2 mt (1 pz) / Steel cable 2 mt (1 pc)
42682	Nero/Black	Sospensione e rosone 2 mt (1 pz) / Suspension and canopy 2 mt (1 pc)
42685	Bianco / White	Sospensione e rosone 2 mt (1 pz) / Suspension and canopy 2 mt (1 pc)
42728	n/a	Attacco a soffitto/Ceiling bracket



**STREAMLIGHT
INCASSO**

LED Samsung
CRI 82
PF 0.9

CODE	FINISHING	WATT	LUMEN	BEAM	KELVIN
42730	Bianco/White	24W	2200	85°*85°	3000K
42731	Bianco/White	24W	2400	85°*85°	4000K

**INSTALLAZIONE
APPLICATION**

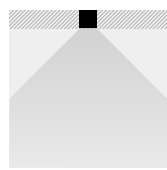

Incasso/Recessed

**DISEGNI TECNICI
TECHNICAL DRAWINGS**

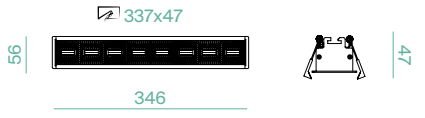

DRIVER

CODE	VOLTAGE	CURRENT	PF	SIZE	MODE
42732	24-42V	650mA	0,9	120x45x30	ON-OFF

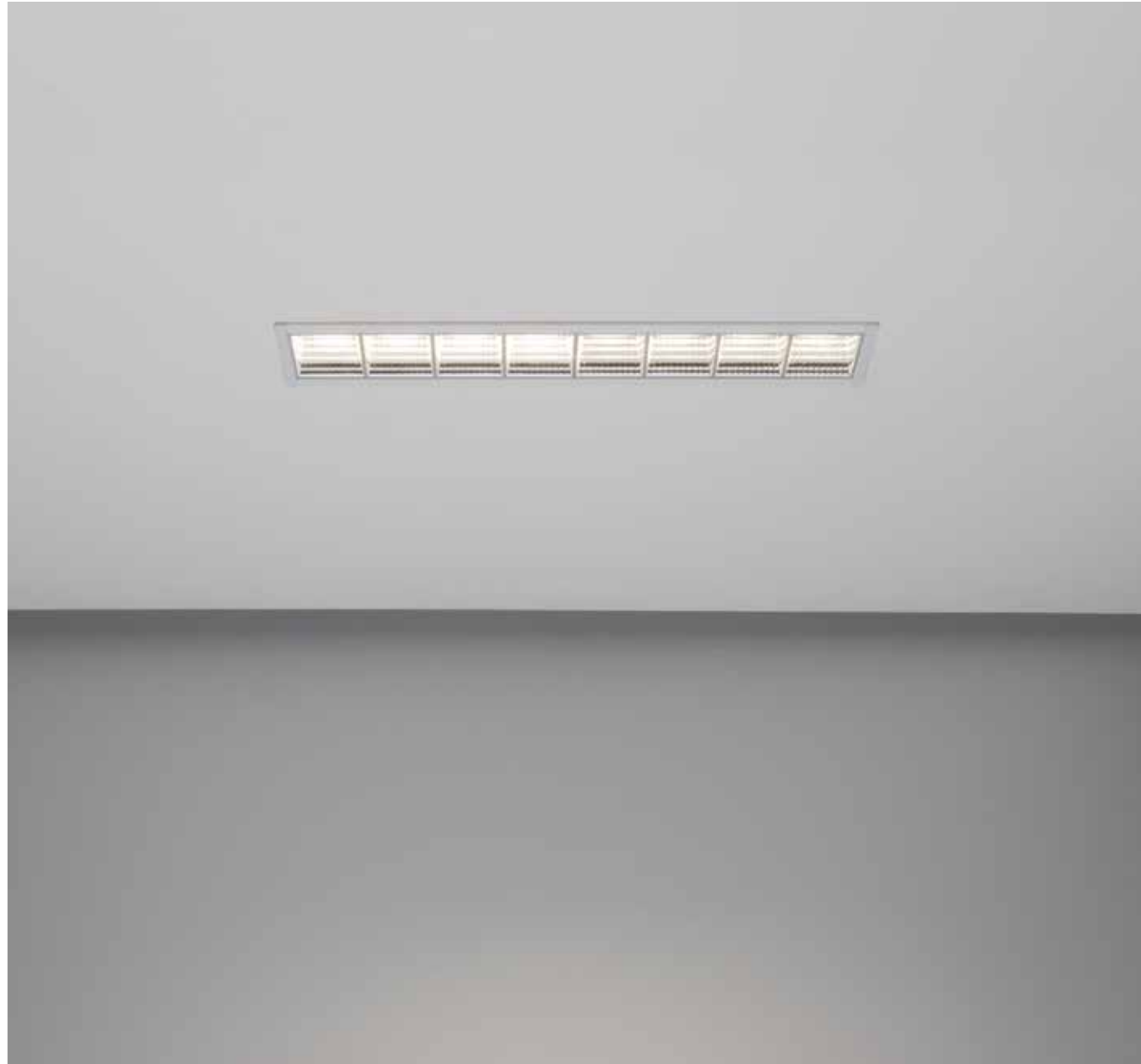

Streamlight incasso/Recessed Streamlight

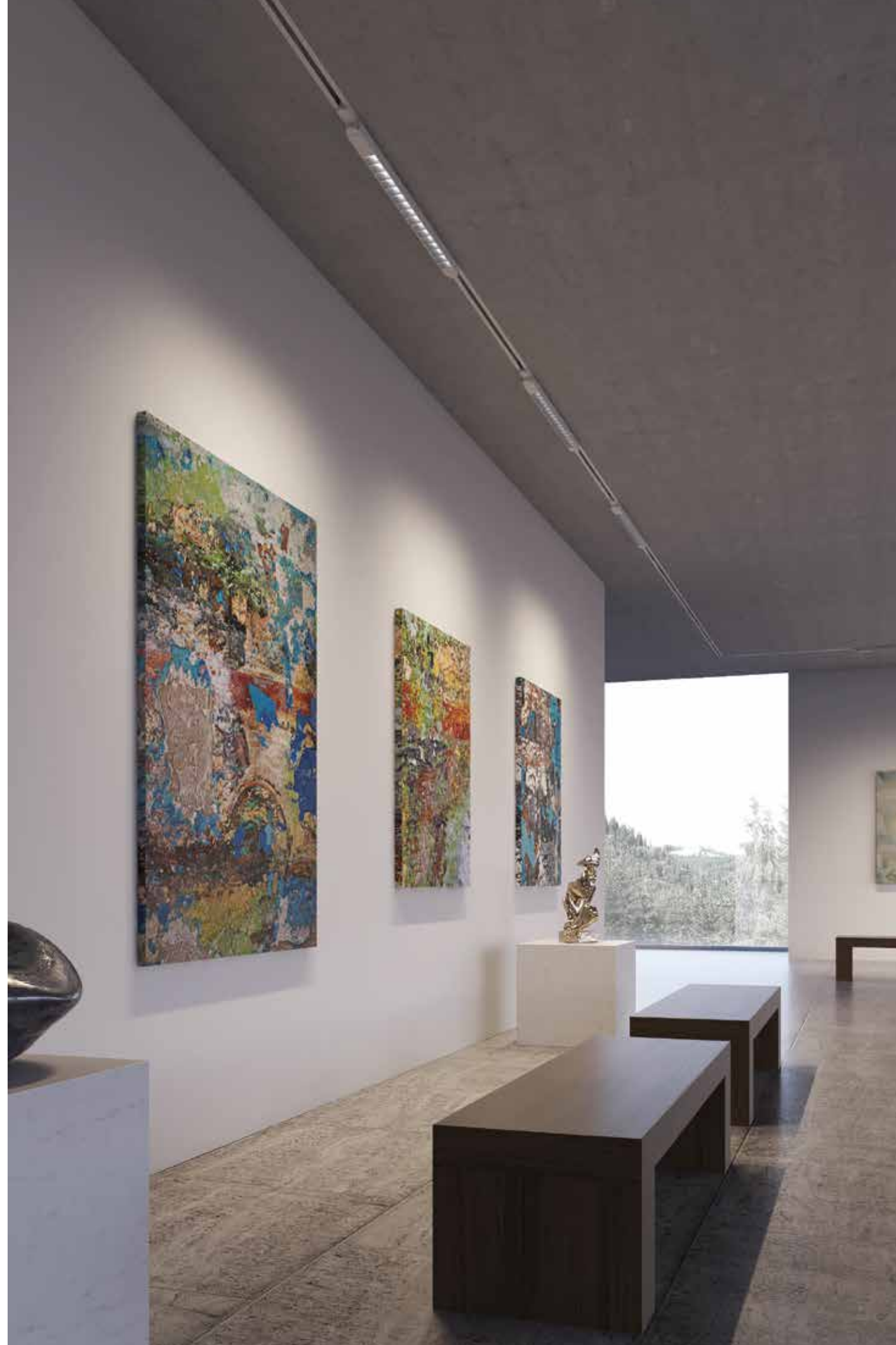

STREAMLIGHT

Apparecchio Led integrato per binario
Corpo in alluminio estruso verniciato
Optica asimmetrica per "wall washer"
Optica simmetrica per illuminazione generale
Driver incorporato

Built-in LED track fitting
Painted die-cast aluminium body
Asymmetric reflector for "wall washer" effect
Symmetric reflector for general lighting
Built-in driver



STREAMLIGHT

LED Samsung
CRI >80
PF 0.9

CODE	MODEL	FINISHING	WATT	LUMEN	BEAM	KELVIN
41094	Asymmetric A	Bianco/White	55W	5600	25°	3000K
41095	Asymmetric A	Bianco/White	55W	5700	25°	4000K
41098	Asymmetric A	Nero/Black	55W	5600	25°	3000K
41099	Asymmetric A	Nero/Black	55W	5700	25°	4000K
41096	Asymmetric B	Bianco/White	55W	5600	25°	3000K
41097	Asymmetric B	Bianco/White	55W	5700	25°	4000K
41100	Asymmetric B	Nero/Black	55W	5600	25°	3000K
41101	Asymmetric B	Nero/Black	55W	5700	25°	4000K
41102	Symmetric	Bianco/White	55W	5600	85°*85°	3000K
41103	Symmetric	Bianco/White	55W	5700	85°*85°	4000K
41104	Symmetric	Nero/Black	55W	5600	85°*85°	3000K
41105	Symmetric	Nero/Black	55W	5700	85°*85°	4000K

INSTALLAZIONE APPLICATION

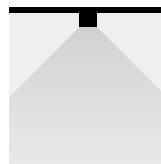

Binario/Track

ASYMMETRIC A

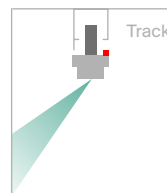

DISEGNI TECNICI TECHNICAL DRAWINGS

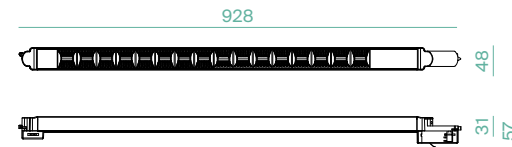

ASYMMETRIC B

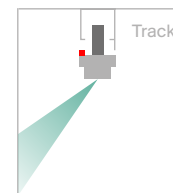

Streamlight

LOGICA

CLARA

Lampada da terra dimmerabile
bi-emissione LED integrato
Corpo in alluminio estruso anodizzato e schermo
anti-glare UGR<19 per luce diretta e schermo
trasparente per luce indiretta

Dimmable LED floor-lamp
for direct and indirect lighting
Extruded and anodized aluminium body
with anti-glare UGR<19 diffuser for direct lighting
and transparent diffuser for indirect lighting

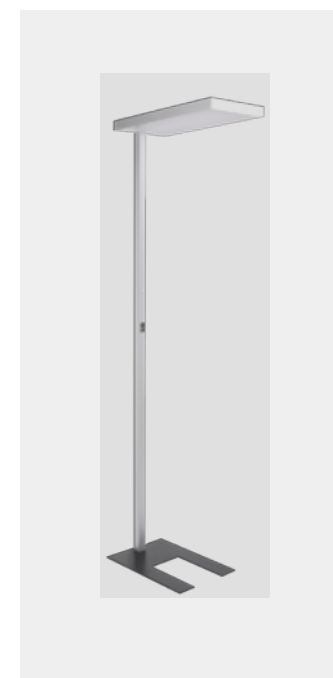

CLARA

LED Samsung
CRI >80
PF >0.98

CODE	FINISHING	WATT	LUMEN	BEAM	KELVIN	DRIVER
41182	Alluminio Anodizzato/ Anodized Aluminium	20W+70W	1800+7200	↑ 120° + ↓ 70°	3000K	Touch dimmable
41148	Alluminio Anodizzato/ Anodized Aluminium	20W+70W	1900+8000	↑ 120° + ↓ 70°	4000K	Touch dimmable

INSTALLAZIONE APPLICATION

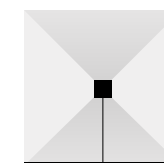

Appoggio/Standing

DISEGNI TECNICI TECHNICAL DRAWINGS

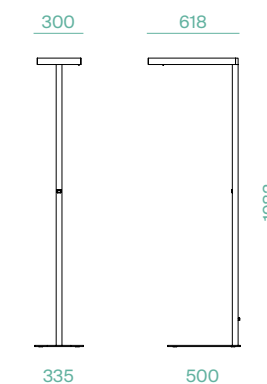

MAGNETIC SYSTEM

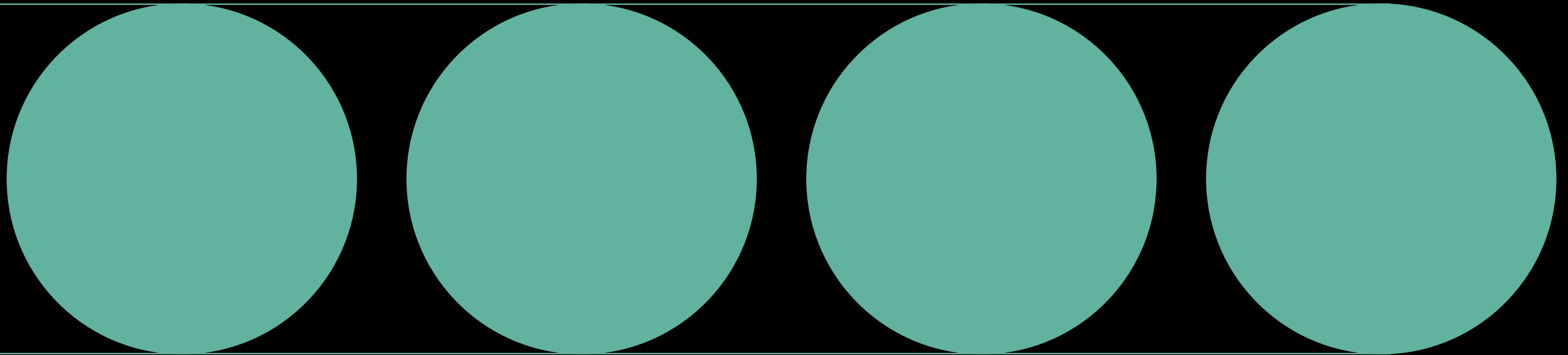



Klik Klak a soffitto nero/Klik Klak black ceiling mount



KLIK KLAK

Apparecchi LED integrato bassa tensione
per binario magnetico

Corpo in alluminio verniciato

Low voltage built-in LED fittings
for magnetic tracks

Painted aluminium body





Un sistema che si adatta
agli spazi e ai loro cambiamenti.
The system that adapts
to spaces and their changes.



SISTEMA MAGNETICO

Il sistema si compone di corpi illuminanti con fissaggio magnetico, semplici da spostare a seconda delle caratteristiche dell'ambiente e in maniera totalmente sicura grazie all'alimentazione a 24V.

MAGNETIC SYSTEM

The system is composed of lighting units with magnetic fixing which can be easily moved along the magnetic profile according to the lighting requirement of the area and in full safety being a 24V low voltage system.

CONFIGURAZIONI
CONFIGURATIONS

INSTALLAZIONE
APPLICATION

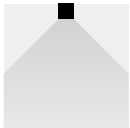

Superficie
Surface



Incasso
Recessed

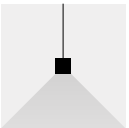

Sospensione
Suspension

FINITURA
FINISHING



Bianco
White



Nero
Black

LUNGHEZZA
LENGTH



1mt



2mt

RACCORDI
JUNCTIONS



90° piano
90° flat



90° esterno
90° outer



90° interno
90° inner

APPARECCHI
FITTINGS

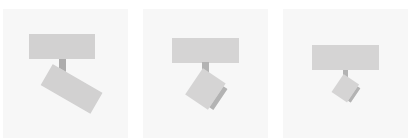

Proiettore
Spotlight

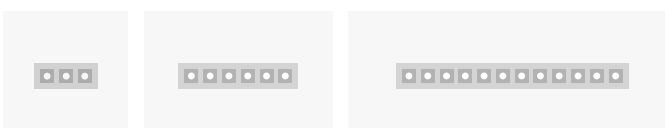

Luce puntiforme
Dot light

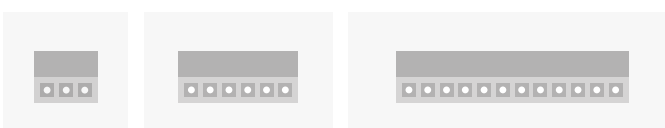

Luce puntiforme orientabile
Adjustable dot lights

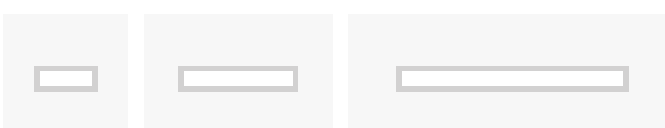

Luce diffusa
General lighting



Sospensione
Suspension



Klik Klak incasso
Recessed Klik Klak

6x Luce puntiforme orientabili/Adjustable dot lights
1x Luce diffusa/General lighting

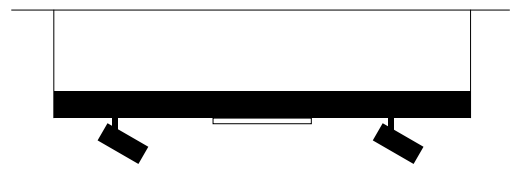

Klik Klak sospensione
Suspension Klik Klak

2x Proiettore/Spotlight
1x Luce diffusa/General lighting



Klik Klak incasso
Recessed Klik Klak

2x Luce puntiforme orientabili/Adjustable dot lights
2x Luce diffusa/General lighting





KLIK KLAK PROIETTORE

LED CRI >90 PF >0.5
CREE >90 >0.5

CODE	FINISHING	WATT	LUMEN	BEAM	KELVIN	APPLICATION
41111	Nero/Black	10W	749	36°	3000K	Magnetic Track
41112	Bianco/White	10W	749	36°	3000K	Magnetic Track
41179	Nero/Black	10W	870	36°	4000K	Magnetic Track
41192	Bianco/White	10W	870	36°	4000K	Magnetic Track

INSTALLAZIONE APPLICATION

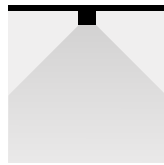

Binario magnetico/
Magnetic track

DISEGNI TECNICI TECHNICAL DRAWINGS

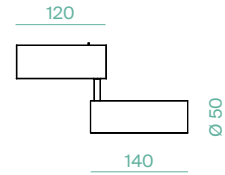

REGOLAZIONI ADJUSTABILITY



KLIK KLAK PROIETTORE

LED CRI >90 PF >0.5
CREE >90 >0.5

CODE	FINISHING	WATT	LUMEN	BEAM	KELVIN	APPLICATION
41176	Nero/Black	8W	404	36°	3000K	Magnetic Track
41175	Bianco/White	8W	404	36°	3000K	Magnetic Track
41178	Nero/Black	15W	904	36°	3000K	Magnetic Track
41177	Bianco/White	15W	904	36°	3000K	Magnetic Track
41214	Nero/Black	8W	404	36°	4000K	Magnetic Track
41213	Bianco/White	8W	404	36°	4000K	Magnetic Track
41216	Nero/Black	15W	904	36°	4000K	Magnetic Track
41215	Bianco/White	15W	904	36°	4000K	Magnetic Track

INSTALLAZIONE APPLICATION

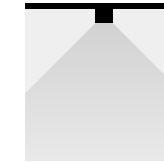

Binario magnetico/
Magnetic track

DISEGNI TECNICI TECHNICAL DRAWINGS

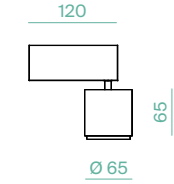

41213
41214
41175
41176

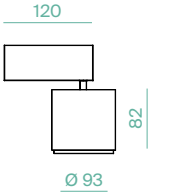

41215
41216
41177
41178

REGOLAZIONI ADJUSTABILITY



KLIK KLAK SOSPENSIONE

LED
CRI >90
PF >0.5

OSRAM
>90
>0.5

CODE	FINISHING	WATT	LUMEN	BEAM	KELVIN	APPLICATION
41174	Nero/Black	10W	714	30°	3000K	Magnetic Track
41173	Bianco/White	10W	714	30°	3000K	Magnetic Track
41212	Nero/Black	10W	714	30°	4000K	Magnetic Track
41211	Bianco/White	10W	714	30°	4000K	Magnetic Track

INSTALLAZIONE APPLICATION

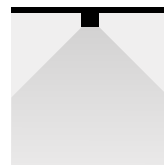

Binario magnetico/
Magnetic track

DISEGNI TECNICI TECHNICAL DRAWINGS

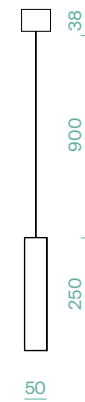

KLIK KLAK PUNTIFORME

LED
CRI >90
PF >0.5

OSRAM
>90
>0.5

CODE	FINISHING	WATT	LUMEN	BEAM	KELVIN	APPLICATION
41119	Nero/Black	4W	375	34°	3000K	Magnetic Track
41122	Bianco/White	4W	375	34°	3000K	Magnetic Track
41120	Nero/Black	8W	788	34°	3000K	Magnetic Track
41123	Bianco/White	8W	788	34°	3000K	Magnetic Track
41121	Nero/Black	16W	1519	34°	3000K	Magnetic Track
41124	Bianco/White	16W	1519	34°	3000K	Magnetic Track
41199	Nero/Black	4W	381	34°	4000K	Magnetic Track
41202	Bianco/White	4W	381	34°	4000K	Magnetic Track
41200	Nero/Black	8W	741	34°	4000K	Magnetic Track
41203	Bianco/White	8W	741	34°	4000K	Magnetic Track
41201	Nero/Black	16W	1530	34°	4000K	Magnetic Track
41204	Bianco/White	16W	1530	34°	4000K	Magnetic Track

INSTALLAZIONE APPLICATION

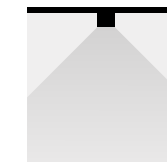

Binario magnetico/
Magnetic track

DISEGNI TECNICI TECHNICAL DRAWINGS

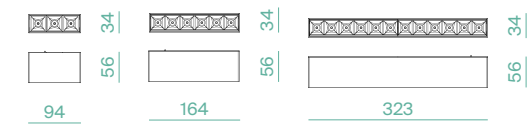

41199	41200	41201
41202	41203	41204
41119	41120	41121
41122	41123	41124

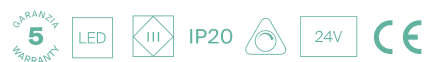



KLIK KLAK PUNIFORME ORIENTABILE

LED
CRI >90
PF >0.5

CODE	FINISHING	WATT	LUMEN	BEAM	KELVIN	APPLICATION
41125	Nero/Black	4W	375	34°	3000K	Magnetic Track
41128	Bianco/White	4W	375	34°	3000K	Magnetic Track
41126	Nero/Black	8W	788	34°	3000K	Magnetic Track
41129	Bianco/White	8W	788	34°	3000K	Magnetic Track
41127	Nero/Black	16W	1519	34°	3000K	Magnetic Track
41130	Bianco/White	16W	1519	34°	3000K	Magnetic Track
41205	Nero/Black	4W	381	34°	4000K	Magnetic Track
41208	Bianco/White	4W	381	34°	4000K	Magnetic Track
41206	Nero/Black	8W	741	34°	4000K	Magnetic Track
41209	Bianco/White	8W	741	34°	4000K	Magnetic Track
41207	Nero/Black	16W	1530	34°	4000K	Magnetic Track
41210	Bianco/White	16W	1530	34°	4000K	Magnetic Track

INSTALLAZIONE APPLICATION

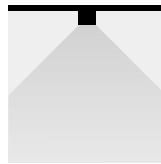

Binario magnetico/
Magnetic track

DISEGNI TECNICI TECHNICAL DRAWINGS

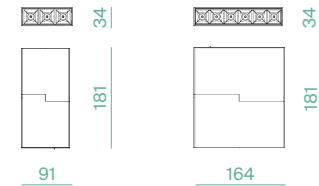

41205
41208
41125
41128

41206
41209
41126
41129

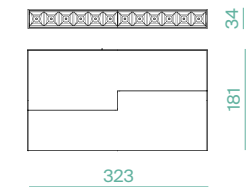

41207
41210
41127
41130

REGOLAZIONI ADJUSTABILITY

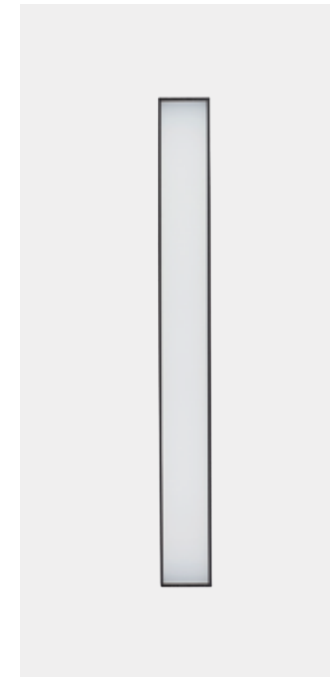

KLIK KLAK LUCE DIFFUSA

LED
CRI >90
PF >0.5

CODE	FINISHING	WATT	LUMEN	BEAM	KELVIN	APPLICATION
41113	Nero/Black	13W	962	34°	3000K	Magnetic Track
41116	Bianco/White	13W	962	34°	3000K	Magnetic Track
41114	Nero/Black	26W	1858	34°	3000K	Magnetic Track
41117	Bianco/White	26W	1858	34°	3000K	Magnetic Track
41115	Nero/Black	39W	2729	34°	3000K	Magnetic Track
41118	Bianco/White	39W	2729	34°	3000K	Magnetic Track
41193	Nero/Black	13W	965	34°	4000K	Magnetic Track
41196	Bianco/White	13W	965	34°	4000K	Magnetic Track
41194	Nero/Black	26W	2030	34°	4000K	Magnetic Track
41197	Bianco/White	26W	2030	34°	4000K	Magnetic Track
41195	Nero/Black	39W	2945	34°	4000K	Magnetic Track
41198	Bianco/White	39W	2945	34°	4000K	Magnetic Track

INSTALLAZIONE APPLICATION

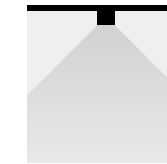

Binario magnetico/
Magnetic track

DISEGNI TECNICI TECHNICAL DRAWINGS



41113
41116

41193
41196



41114
41117

41194
41197



41115
41118

41195
41198



ACCESSORI ACCESSORIES

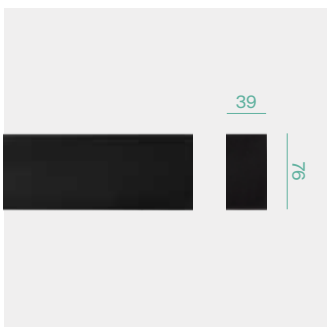

41109 - 41110 - 41144 - 41145



41146

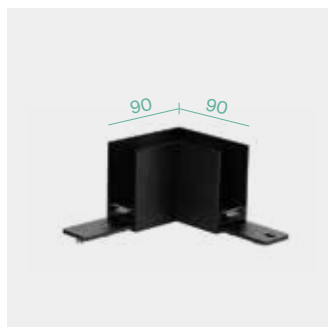

41136 - 41137



41138 - 41139



41140 - 41141



41142 - 41143



41131

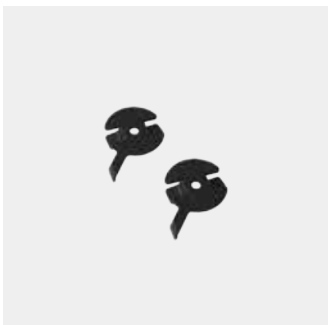

41222 - 41223

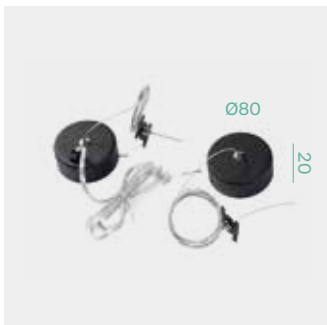

41132 - 41132/A - 41133 - 41133/A



41134 - 41135



41240 - 41241



42787 - 42784 - 42788 - 42785



42789 - 42786

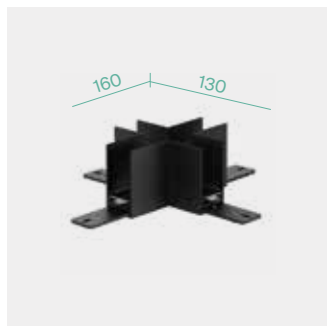

41257 - 41258

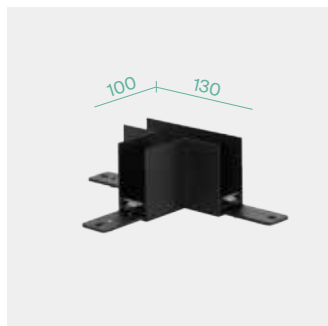

41259 - 41260

CODE	FINISHING	DESCRIPTION
41109	Nero / Black	Struttura 1mt in alluminio estruso con testate / 1mt extruded aluminium profile with end-caps
41110	Bianco / White	Struttura 1mt in alluminio estruso con testate / 1mt extruded aluminium profile with end-caps
41144	Nero / Black	Struttura 2mt in alluminio estruso con testate / 2mt extruded aluminium profile with end-caps
41145	Bianco / White	Struttura 2mt in alluminio estruso con testate / 2mt extruded aluminium profile with end-caps
41146	Nero / Black	Copertura per rasatura 1 mt / 1 mt mask for plasterboard thinning

ACCESSORI ACCESSORIES

CODE	FINISHING	DESCRIPTION
41136	Nero / Black	Angolo 90° con spinotti e staffe connessione / 90° corner with relative 3-pins connectors and connection plates
41137	Bianco / White	Angolo 90° con spinotti e staffe connessione / 90° corner with relative 3-pins connectors and connection plates
41138	Nero / Black	Angolo 90° esterno con spinotti e staffe connessione / Outer 90° corner with relative 3-pins connectors and connection plates
41139	Bianco / White	Angolo 90° esterno con spinotti e staffe connessione / Outer 90° corner with relative 3-pins connectors and connection plates
41140	Nero / Black	Angolo 90° interno con spinotti e staffe connessione / Inner 90° corner with relative 3-pins connectors and connection plates
41141	Bianco / White	Angolo 90° interno con spinotti e staffe connessione / Inner 90° corner with relative 3-pins connectors and connection plates
41142	Nero / Black	Congiunzione elettrica con spinotti / Linear 65mm electric connection with relative 3-pins connector
41143	Bianco / White	Congiunzione elettrica con spinotti / Linear 65mm electric connection with relative 3-pins connector
41131	Nero / Black	Kit staffe incasso (2 pz) / Brackets for recessed installation (2 pcs)
41222	Nero / Black	Staffe attacco soffitto kit 2pz / Brackets for ceiling installation 2 pcs
41223	Bianco / White	Staffe attacco soffitto kit 2pz / Brackets for ceiling installation (2 pcs)
41132	Nero / Black	Sospensione 2mt (1 pz) / Suspension 2mt (1 pc)
41132/A	Nero / Black	Sospensione con cavo alimentazione 2mt (1 pz) / Suspension 2mt with electrical wire (1 pc)
41133	Bianco / White	Sospensione 2mt (1 pz) / Suspension 2mt (1 pc)
41133/A	Bianco / White	Sospensione con cavo alimentazione 2mt (1 pz) / Suspension 2mt with electrical wire (1 pc)
41134	Nero / Black	Staffa connessione (1 pz) / Linear connection plate (1 pc)
41135	Bianco / White	Staffa connessione (1 pz) / Linear connection plate (1 pc)
41258	Nero / Black	Giunto a "X"/"X" connector
41257	Bianco / White	Giunto a "X"/"X" connector
41260	Nero / Black	Giunto a "T"/"T" connector
41259	Bianco / White	Giunto a "T"/"T" connector
41241	Nero / Black	Testata per alimentazione 24V / Front feed 24V
41240	Bianco / White	Testata per alimentazione 24V / Front feed 24V
42787	Nero / Black	Testata c/ driver 75W 230V dimm. / Front feed w/ driver 75W 230V dimm.
42784	Bianco / White	Testata c/ driver 75W 230V dimm. / Front feed w/ driver 75W 230V dimm.
42788	Nero / Black	Testata c/ driver 100W 230V dimm. / Front feed w/ driver 100W 230V dimm.
42785	Bianco / White	Testata c/ driver 100W 230V dimm. / Front feed w/ driver 100W 230V dimm.
42789	Nero / Black	Testata c/ driver 150W 230V dimm. / Front feed w/ driver 150W 230V dimm.
42786	Bianco / White	Testata c/ driver 150W 230V dimm. / Front feed w/ driver 150W 230V dimm.

DRIVER

CODE	WATT	V	DESCRIPTION	SIZE	MODE
22015	50W	24V DC	Driver	99x82x30mm	ON-OFF
22031	60W	24V DC	Driver EAGLERISE TRP	187x45x31mm	ON-OFF
22032	75W	24V DC	Driver EAGLERISE TRP	187x45x31mm	ON-OFF
22016	100W	24V DC	Driver	129x97x30mm	ON-OFF
22033	120W	24V DC	Driver EAGLERISE TRP	268x45x31mm	ON-OFF
22034	150W	24V DC	Driver EAGLERISE TRP	268x45x31mm	ON-OFF
22025	150W	24V DC	Driver	160x95x30mm	ON-OFF
22017	200W	24V DC	Driver	215x115x30mm	ON-OFF
41217	75W	24V DC	Driver dimmerabile	144x78x38.5mm	1-10V
41218	96W	24V DC	Driver dimmerabile	240x70x36mm	1-10V
41219	200W	24V DC	Driver dimmerabile	270x79x39mm	1-10V



Klik Klak nero con sospensione/Klik Klak black with suspension

TRACK SPOTLIGHTS

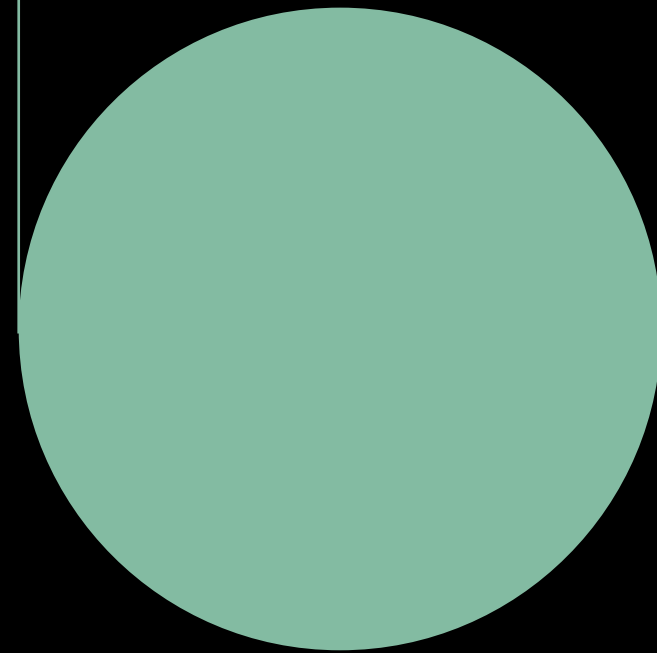
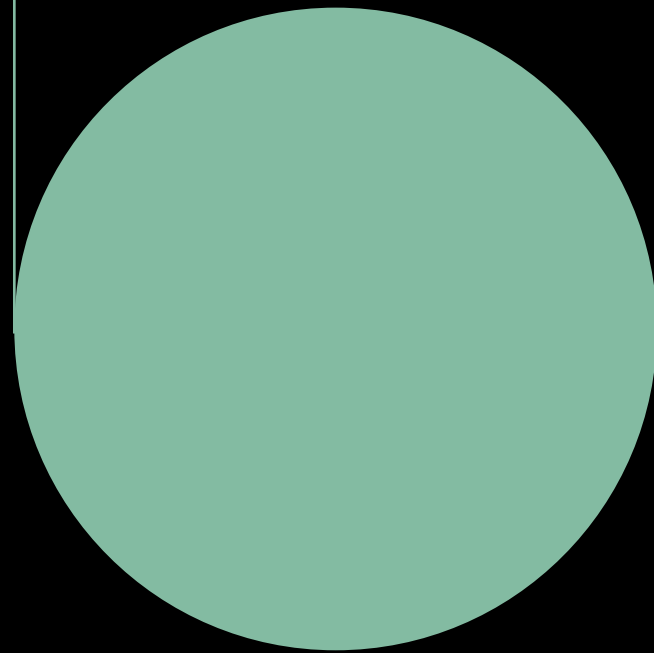
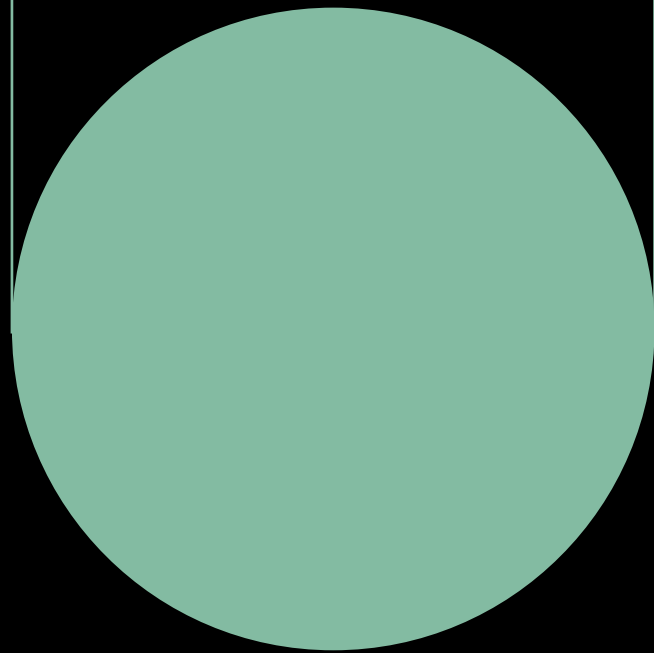
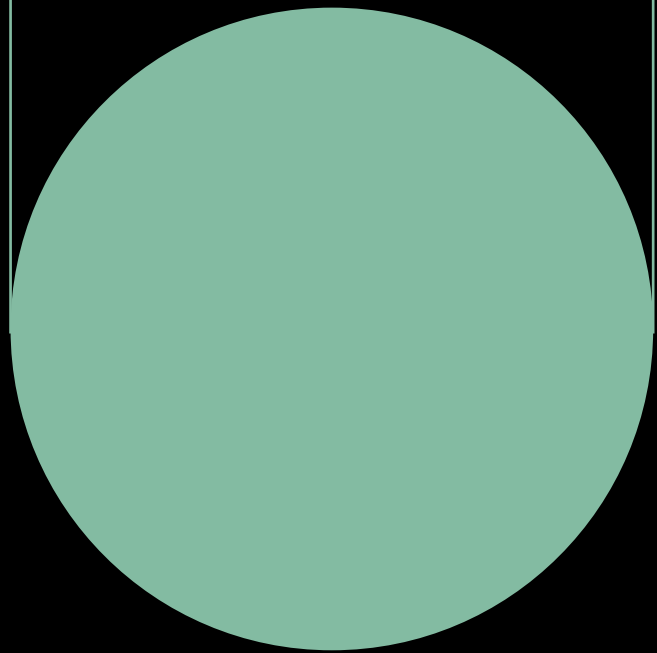

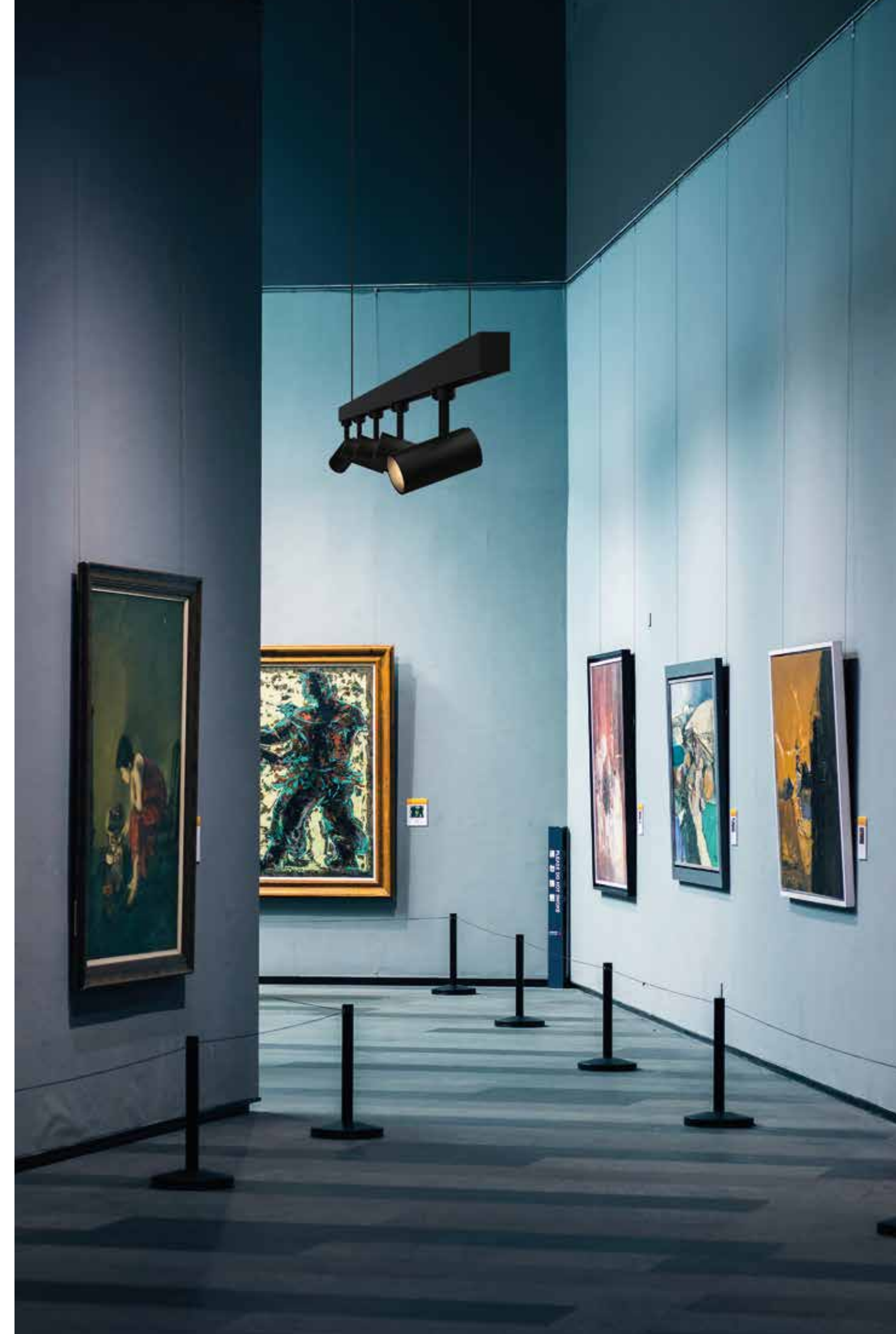

FULGOR

Proiettore LED integrato orientabile
Corpo in alluminio pressofuso verniciato
Driver integrato

LED adjustable tracklight
Painted die-cast aluminium body
Driver box on trac

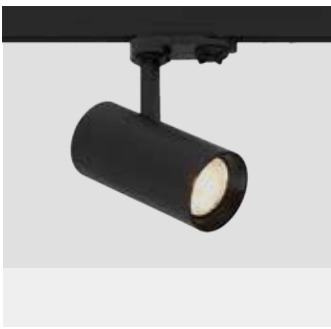

FULGOR

LED
CRI >90
PF 0.9

Bridgelux

CODE	FINISHING	WATT	LUMEN	BEAM	KELVIN	DRIVER
41666	Bianco/white	24W	2300	55°	3000K	30-40V 600mA
41668	Nero/Black	24W	2300	55°	3000K	30-40V 600mA
41667	Bianco/white	24W	2680	55°	4000K	30-40V 600mA
41669	Nero/Black	24W	2680	55°	4000K	30-40V 600mA
41670	Bianco/white	24W	2300	38°	3000K	30-40V 600mA
41671	Nero/Black	24W	2300	38°	3000K	30-40V 600mA
41672	Bianco/white	24W	2680	38°	4000K	30-40V 600mA
41673	Nero/Black	24W	2680	38°	4000K	30-40V 600mA
41674	Bianco/white	24W	2300	24°	3000K	30-40V 600mA
41675	Nero/Black	24W	2300	24°	3000K	30-40V 600mA
41676	Bianco/white	24W	2680	24°	4000K	30-40V 600mA
41677	Nero/Black	24W	2680	24°	4000K	30-40V 600mA
41678	Bianco/white	24W	2300	15°	3000K	30-40V 600mA
41679	Nero/Black	24W	2300	15°	3000K	30-40V 600mA
41680	Bianco/white	24W	2680	15°	4000K	30-40V 600mA
41681	Nero/Black	24W	2680	15°	4000K	30-40V 600mA

INSTALLAZIONE APPLICATION

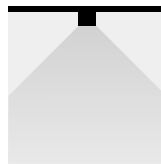

Binario/Track

DISEGNI TECNICI TECHNICAL DRAWINGS

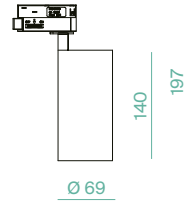

REGOLAZIONI ADJUSTABILITY



5 GARANZIA WARRANTY LED IP20 230V 50/60Hz CE

Fulgor nero/Black Fulgor

LOGICA



UNICO COMPACT

Proiettore led integrato da binario orientabile
Corpo in alluminio pressofuso verniciato
Riflettore brillantato
Driver integrato

LED adjustable tracklight
Painted die-cast aluminium body
with multifaceted reflector
Built-in driver



UNICO_COMPACT

LED
CRI
PF

CREE/PHILIPS
>80
0.9

CODE	FINISHING	WATT	LUMEN	BEAM	KELVIN	DRIVER
40651	Bianco/White	18W	2000	60°	3000K	550mA/33V
40655	Nero/Black	18W	2000	60°	3000K	550mA/33V
40653	Bianco/White	18W	2200	60°	4000K	550mA/33V
40657	Nero/Black	18W	2200	60°	4000K	550mA/33V
40692	Bianco/White	18W	2000	40°	3000K	550mA/33V
40696	Nero/Black	18W	2000	40°	3000K	550mA/33V
40694	Bianco/White	18W	2200	40°	4000K	550mA/33V
40698	Nero/Black	18W	2200	40°	4000K	550mA/33V
40659	Bianco/White	18W	2000	24°	3000K	550mA/33V
40664	Nero/Black	18W	2000	24°	3000K	550mA/33V
40662	Bianco/White	18W	2200	24°	4000K	550mA/33V
40666	Nero/Black	18W	2200	24°	4000K	550mA/33V

INSTALLAZIONE APPLICATION

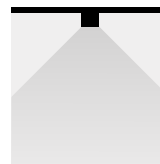

Binario/Track

DISEGNI TECNICI TECHNICAL DRAWINGS

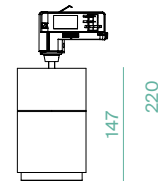

Ø 90

REGOLAZIONI ADJUSTABILITY



355°
90°



UNICO_COMPACT

LED
CRI
PF

CREE/PHILIPS
>80
0.9

CODE	FINISHING	WATT	LUMEN	BEAM	KELVIN	DRIVER
40652	Bianco/White	26W	2500	60°	3000K	700mA/37V
40656	Nero/Black	26W	2500	60°	3000K	700mA/37V
40654	Bianco/White	26W	2700	60°	4000K	700mA/37V
40658	Nero/Black	26W	2700	60°	4000K	700mA/37V
40693	Bianco/White	26W	2500	40°	3000K	700mA/37V
40697	Nero/Black	26W	2500	40°	3000K	700mA/37V
40695	Bianco/White	26W	2700	40°	4000K	700mA/37V
40699	Nero/Black	26W	2700	40°	4000K	700mA/37V
40661	Bianco/White	26W	2500	24°	3000K	700mA/37V
40665	Nero/Black	26W	2500	24°	3000K	700mA/37V
40663	Bianco/White	26W	2700	24°	4000K	700mA/37V
40667	Nero/Black	26W	2700	24°	4000K	700mA/37V

INSTALLAZIONE APPLICATION

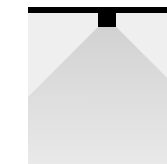

Binario/Track

DISEGNI TECNICI TECHNICAL DRAWINGS

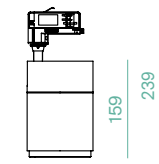

Ø 110

REGOLAZIONI ADJUSTABILITY

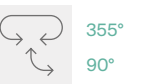

355°
90°





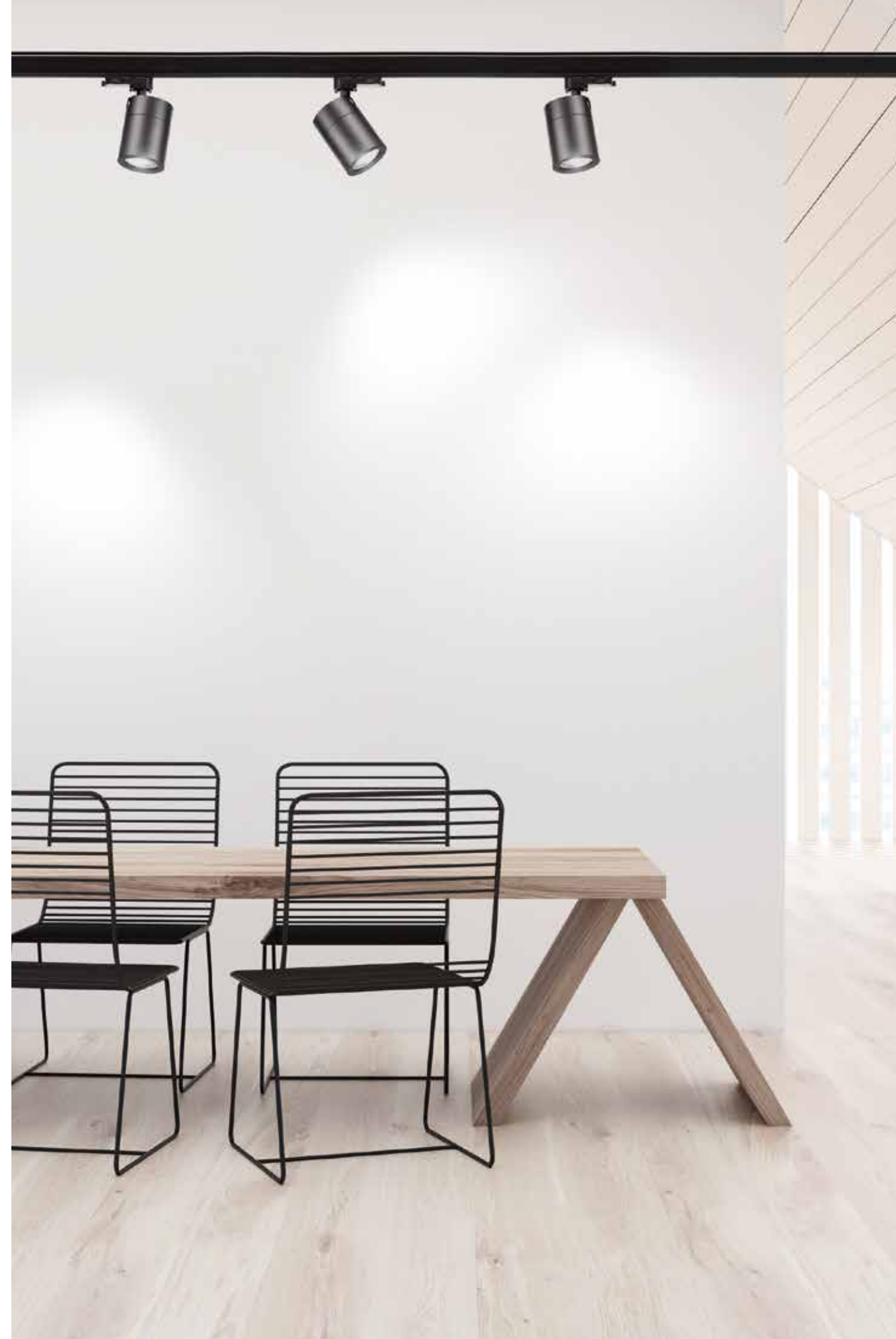

UNICO DICRO

Proiettore orientabile per lampade LED DICRO
Corpo in alluminio verniciato
Montaggio a binario, soffitto o parete
Lampadina non inclusa

Adjustable tracklight for LED DICRO bulbs
Painted aluminium body
Track, ceiling or wall mounting
Bulb not included

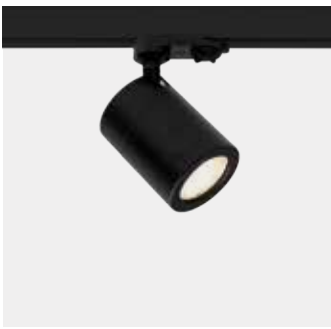

UNICO DICRO

Lampadina esclusa / Bulb not included

CODE	FINISHING	BASE
40758	Bianco/White	GU10 230V 50/60HZ
40759	Nero/Black	GU10 230V 50/60HZ

INSTALLAZIONE APPLICATION

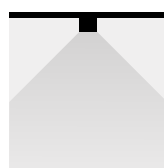

Binario/Track

DISEGNI TECNICI TECHNICAL DRAWINGS

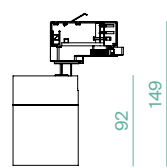

Ø 68

REGOLAZIONI ADJUSTABILITY



355°

90°



UNICO DICRO SOFFITTO/PARETE

Lampadina esclusa / Bulb not included

CODE	FINISHING	BASE
40760	Bianco/White	GU10 230V 50/60HZ
40761	Nero/Black	GU10 230V 50/60HZ

INSTALLAZIONE APPLICATION

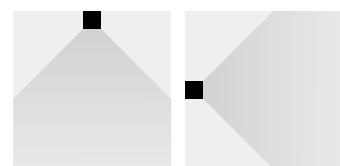

Soffitto/Ceiling

Parete/Wall

DISEGNI TECNICI TECHNICAL DRAWINGS

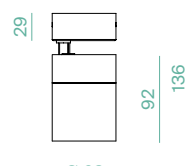

Ø 68

REGOLAZIONI ADJUSTABILITY



355°

90°



Unico Dicro a soffitto bianco/Unico Dicro ceiling mount white



UNICO AR111

Lampadina esclusa / Bulb not included

CODE	FINISHING	BASE
40754	Bianco/White	AR111 GU10 230V 50/60HZ
40755	Nero/Black	AR111 GU10 230V 50/60HZ

INSTALLAZIONE APPLICATION

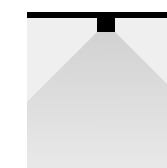

Binario/Track

DISEGNI TECNICI TECHNICAL DRAWINGS

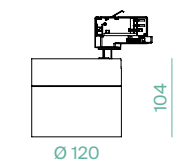

REGOLAZIONI ADJUSTABILITY



UNICO AR111

Proiettore orientabile per lampade LED AR111
Corpo in alluminio verniciato
Montaggio a binario
Lampadina non inclusa

Adjustable tracklight for AR111 LED bulbs
Painted aluminium body
Track mounting
Bulbs not included



Unico Dicro



Fulgor



Unico AR111





ORBIT

Lampadina esclusa / Bulb not included

CODE	FINISHING	BASE
53840	Bianco/White	GU10 230V 50/60HZ
53841	Nero/Black	GU10 230V 50/60HZ

INSTALLAZIONE APPLICATION

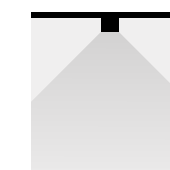

Binario/Track

DISEGNI TECNICI TECHNICAL DRAWINGS

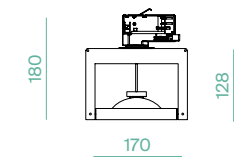

REGOLAZIONI ADJUSTABILITY

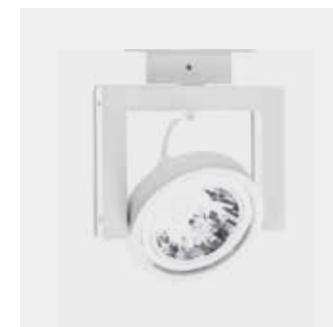
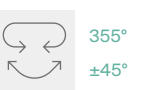

ORBIT SOFFITTO/PARETE

Lampadina esclusa / Bulb not included

CODE	FINISHING	BASE
53842	Bianco/White	GU10 230V 50/60HZ
53843	Nero/Black	GU10 230V 50/60HZ

INSTALLAZIONE APPLICATION

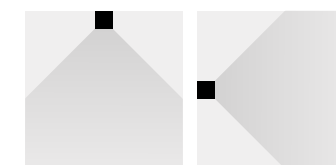

Soffitto/Ceiling

Parete/Wall

DISEGNI TECNICI TECHNICAL DRAWINGS

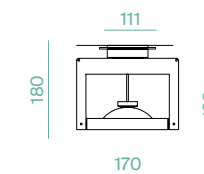

REGOLAZIONI ADJUSTABILITY

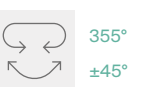

ORBIT

Proiettore per lampade LED AR111 orientabile
Corpo in alluminio verniciato
Montaggio a binario, soffitto, parete
Lampadina non inclusa

Adjustable tracklight for LED AR111 bulbs
Painted aluminium body
Track, ceiling or wall mounting
Bulbs not included



TRACK COVER

Profilo in alluminio estruso
Ingloba il binario standard migliorandone l'estetica
Vano superiore utilizzabile come canalina di servizio
o per alloggiare un'illuminazione indiretta

Extruded aluminium profile
It incorporates the standard track and it improves
its aesthetic
The upper area can be used either as wiring space
or it can host other sources for indirect lighting



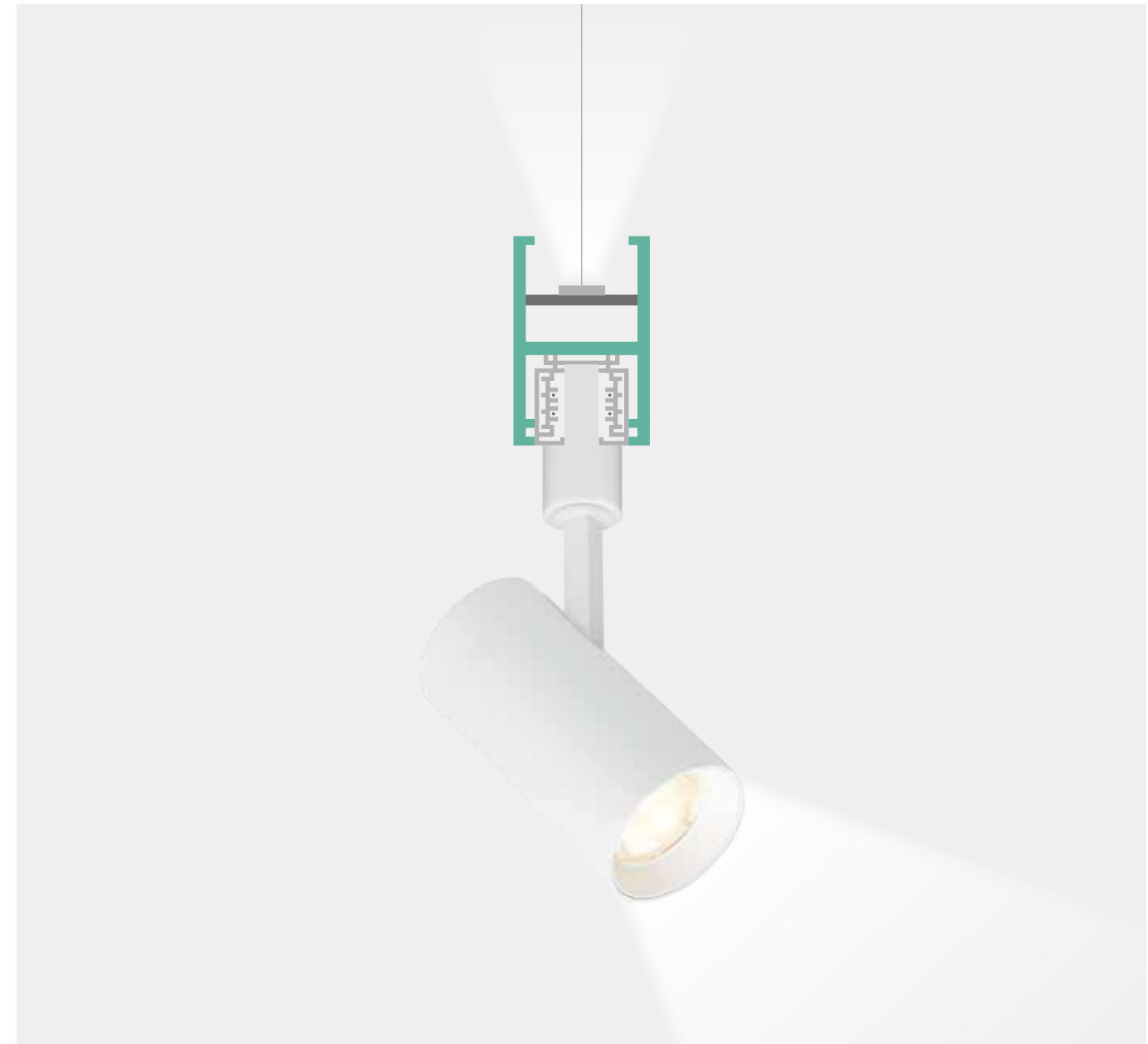
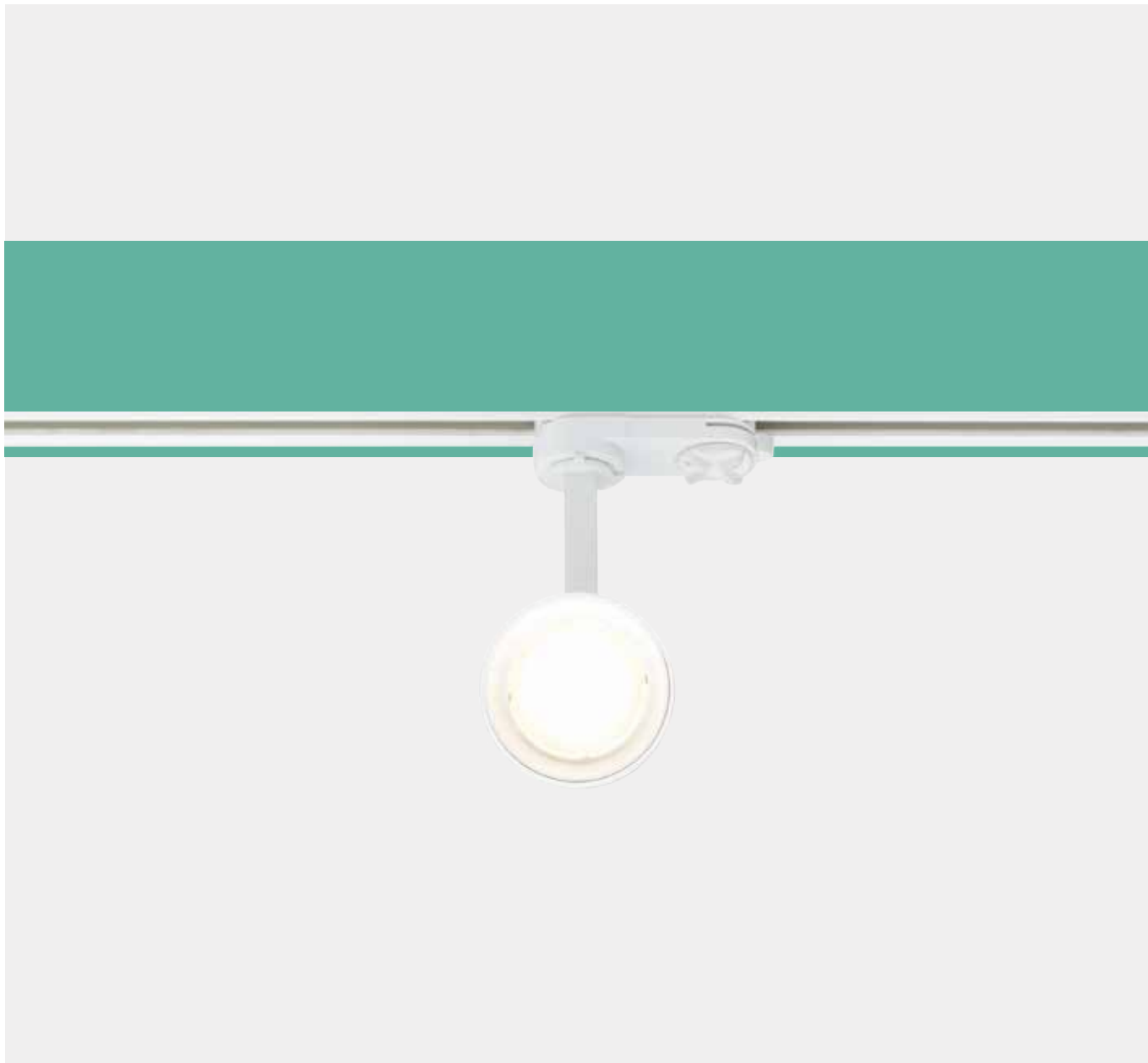

ESTETICA

Track_Cover permette di trasformare un binario standard in un prodotto consono ad essere inserito in contesti architettonici.

AESTHETICS

Track_Cover is able to turn a standard track into a product which can perfectly suit an architectural environment.

FUNZIONALE

Track_Cover moltiplica le possibilità di utilizzo del classico binario, rendendolo adatto anche in contesti nei quali è richiesta una luce indiretta: nell'installazione a sospensione si può inserire un'ampia gamma di stripLED che vanno a integrare la precisione degli spotlights.

FUNCTIONALITY

Track_Cover multiplies the opportunities to use the standard tracks adding the option to use a general indirect lighting: when installed suspended, a wide range of LED strips can integrate the spotlights' precision.



TRACK_COVER

CODE	FINISHING	DESCRIPTION
60127	Bianco/White	TRACK_COVER profilo 1mt/TRACK_COVER profile 1mt
60130	Nero/Black	TRACK_COVER profilo 1mt/TRACK_COVER profile 1mt
60128	Bianco/White	TRACK_COVER profilo 2mt/TRACK_COVER profile 2mt
60131	Nero/Black	TRACK_COVER profilo 2mt/TRACK_COVER profile 2mt
60129	Bianco/White	TRACK_COVER profilo 3mt/TRACK_COVER profile 3mt
60132	Nero/Black	TRACK_COVER profilo 3mt/TRACK_COVER profile 3mt

INSTALLAZIONE APPLICATION

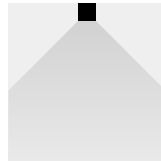

Soffitto/Ceiling

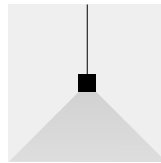

Sospensione/Suspension

DISEGNI TECNICI TECHNICAL DRAWINGS

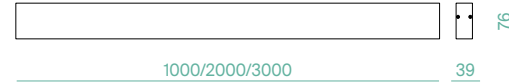

ACCESSORI ACCESSORIES



60133 - 60134

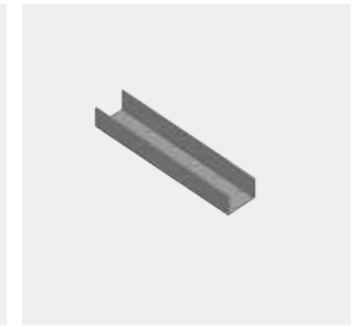

60135

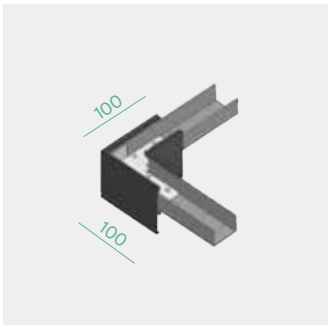

60137 - 60138

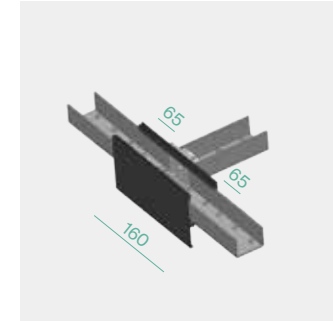

60139 - 60140

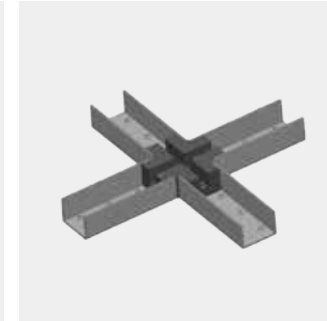

60141 - 60142



60143 - 60144



60145 - 60146

CODE	FINISHING	DESCRIPTION
60134	Bianco / White	Testata 1 pz / End cap 1 pc
60133	Nero / Black	Testata 1 pz / End cap 1 pc
60135	Alluminio/ Aluminium	Congiunzione Lineare/Linear Connector
60137	Bianco / White	Giunto "L"/L-Connector
60138	Nero / Black	Giunto "L"/L-Connector
60139	Bianco / White	Giunto "T"/T-Connector
60140	Nero / Black	Giunto "T"/T-Connector
60141	Bianco / White	Giunto "X"/X-Connector
60142	Nero / Black	Giunto "X"/X-Connector
60143	Bianco / White	Attacco soffitto / Ceiling bracket
60144	Nero / Black	Attacco soffitto / Ceiling bracket
60145	Bianco / White	Sospensione 1,5 mt / Pendant kit 1,5 mt
60146	Nero / Black	Sospensione 1,5 mt / Pendant kit 1,5 mt



TRACKS

CODE	FINISHING	DESCRIPTION
60037	Nero/Black	Euro-track binario/track 1 mt.
60040	Nero/Black	Euro-track binario/track 2 mt.
60043	Nero/Black	Euro-track binario/track 3 mt.
60038	Bianco/White	Euro-track binario/track 1 mt.
60041	Bianco/White	Euro-track binario/track 2 mt.
60044	Bianco/White	Euro-track binario/track 3 mt.

INSTALLAZIONE APPLICATION



Soffitto/Ceiling

DISEGNI TECNICI TECHNICAL DRAWINGS

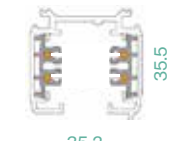

35.5

35.2

TRACKS INCASSO

CODE	FINISHING	DESCRIPTION
60100	Nero/Black	Track 2 mt.
60102	Nero/Black	Track 2 mt.
60101	Bianco/White	Track 3 mt.
60103	Bianco/White	Track 3 mt.

INSTALLAZIONE APPLICATION

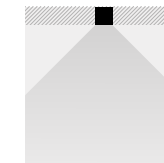

Incasso/Recessed

DISEGNI TECNICI TECHNICAL DRAWINGS

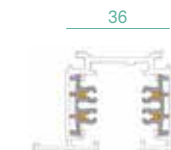

36

35.5

56

ACCESSORI
ACCESSORIES

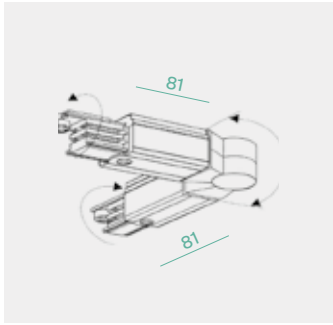

60046 - 60047

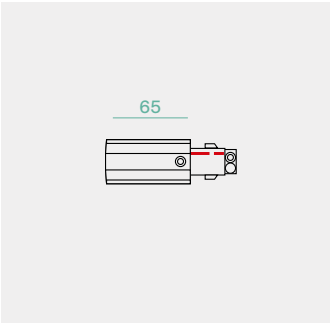

60049 - 60050

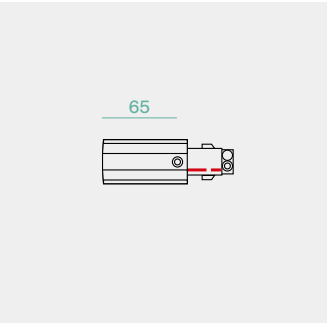

60052 - 60053

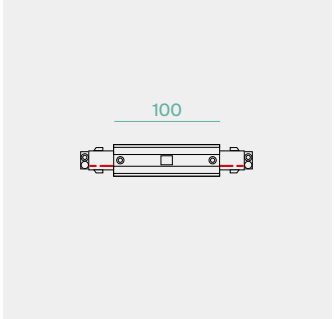

60084 - 60085

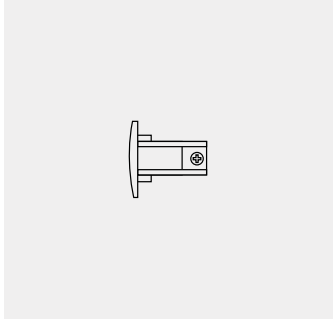

60055 - 60056



60088 - 60089



60086 - 60087

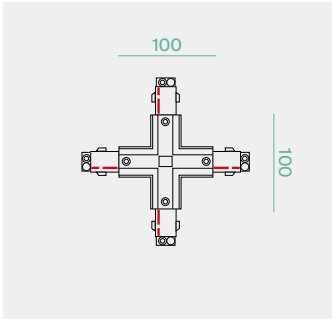

60079 - 60080

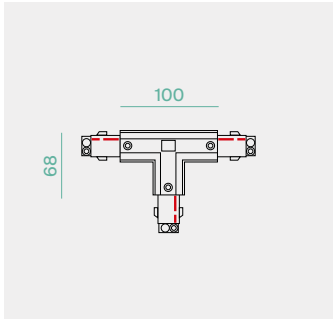

60067 - 60068

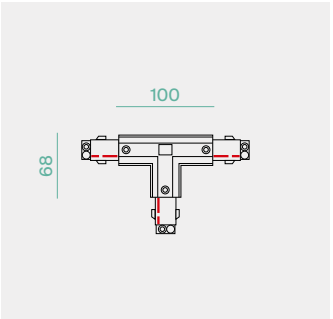

60070 - 60071

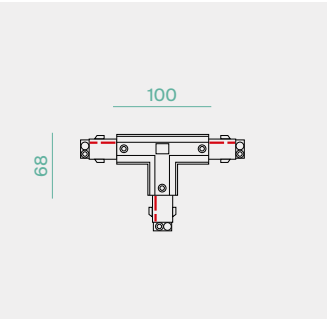

60073 - 60074

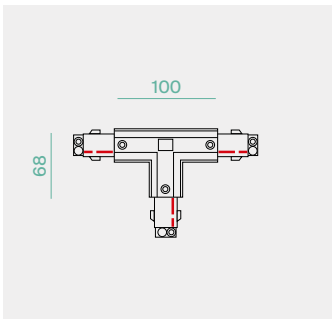

60076 - 60077

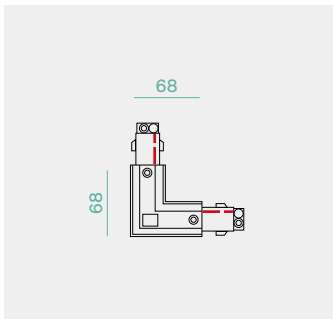

60061 - 60062

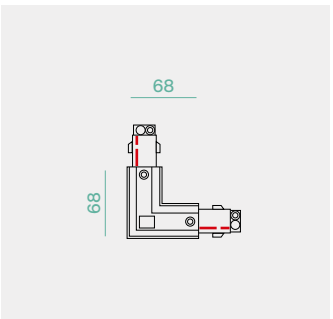

60064 - 60065

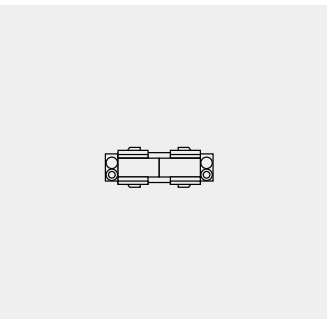

60058 - 60059

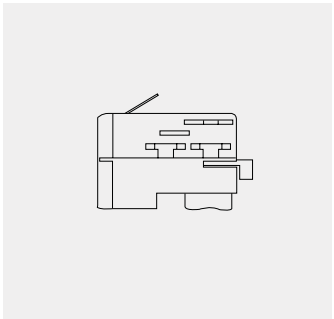

52582/N - 52582/B



11620 - 11621

ACCESSORI
ACCESSORIES

CODE	FINISHING	DESCRIPTION
60046	Nero/Black	Curva regolabile/Adjustable junction
60047	Bianco/White	Curva regolabile/Adjustable junction
60049	Nero/Black	Alimentazione sinistra/Left feed
60050	Bianco/White	Alimentazione sinistra/Left feed
60052	Nero/Black	Alimentazione destra/Right feed
60053	Bianco/White	Alimentazione destra/Right feed
60084	Nero/Black	Alimentazione centrale/Middle feed
60085	Bianco/White	Alimentazione centrale/Middle feed
60055	Nero/Black	Testata di chiusura/End-cap
60056	Bianco/White	Testata di chiusura/End-cap
60088	Nero/Black	Kit sospensione con cavo 2 mt./Suspension kit with cable 2 mt.
60089	Bianco/White	Kit sospensione con cavo 2 mt./Suspension kit with cable 2 mt.
60086	Nero/Black	Staffa soffitto/Ceiling bracket
60087	Bianco/White	Staffa soffitto/Ceiling bracket
60079	Nero/Black	Giunto "+"/"+" connector
60080	Bianco/White	Giunto "+"/"+" connector
60067	Nero/Black	Giunto-1 "T"/"T"connector-1
60068	Bianco/White	Giunto-1 "T"/"T"connector-1
60070	Nero/Black	Giunto-2 "T"/"T"connector-2
60071	Bianco/White	Giunto-2 "T"/"T"connector-2
60073	Nero/Black	Giunto-3 "T"/"T"connector-3
60074	Bianco/White	Giunto-3 "T"/"T"connector-3
60076	Nero/Black	Giunto-4 "T"/"T"connector-4
60077	Bianco/White	Giunto-4 "T"/"T"connector-4
60061	Nero/Black	Giunto-1 "L"/"L"connector-1
60062	Bianco/White	Giunto-1 "L"/"L"connector-1
60064	Nero/Black	Giunto-2 "L"/"L"connector-2
60065	Bianco/White	Giunto-2 "L"/"L"connector-2
60058	Nero/Black	Congiunzione/ straight connector
60059	Bianco/White	Congiunzione/ straight connector
52582/N	Nero/Black	Adattatore binario/track adaptor
52582/B	Bianco/White	Adattatore binario/track adaptor
11621	Nero/Black	Accessorio soffitto per Euro-track / Euro-track ceiling accessory
11620	Bianco/White	Accessorio soffitto per Euro-track / Euro-track ceiling accessory

ACCESSORI
ACCESSORIES

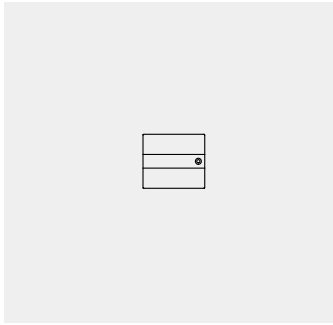

60104 - 60105

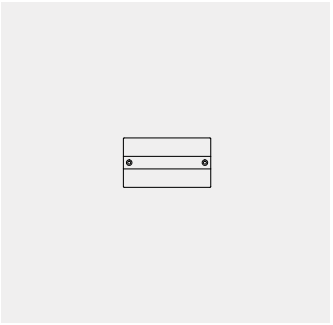

60106 - 60107

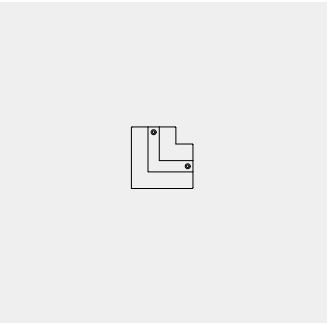

60108 - 60109

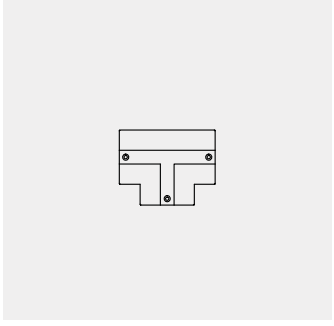

60110 - 60111

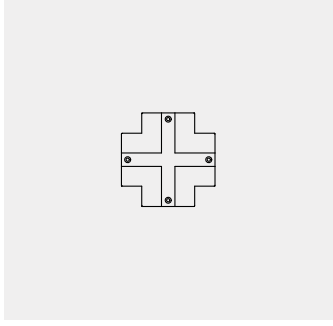

60112 - 60113

ACCESSORI
ACCESSORIES

CODE	FINISHING	DESCRIPTION
60104	Nero/Black	Copertura alim. sx/dx binario incasso/ Right/left feed cover
60105	Bianco/White	Copertura alim. sx/dx binario incasso/ Right/left feed cover
60106	Nero/Black	Copertura alim. centrale binario incasso/ Middle feed cover
60107	Bianco/White	Copertura alim. centrale binario incasso/ Middle feed cover
60108	Nero/Black	Copertura giunto "L" binario incasso/ "L" connector cover
60109	Bianco/White	Copertura giunto "L" binario incasso/ "L" connector cover
60110	Nero/Black	Copertura giunto "T" binario incasso/ "T" connector cover
60111	Bianco/White	Copertura giunto "T" binario incasso/ "T" connector cover
60112	Nero/Black	Copertura giunto "+" binario incasso/ "+" connector cover
60113	Bianco/White	Copertura giunto "+" binario incasso/ "+" connector cover

EMERGENZA



Lampada emergenza 3W per binari
Autonomia 3 H
Emergency track lamp 3W
3 Hours autonomy

CODE	FINISHING	WATT	LUMEN	KELVIN
60091	Nero/Black	3W	110	3000K
60092	Bianco/White	3W	110	3000K

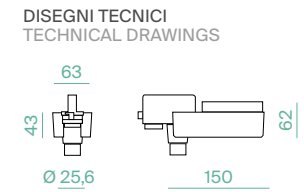
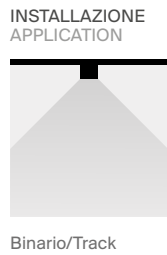

DOWNLIGHTS

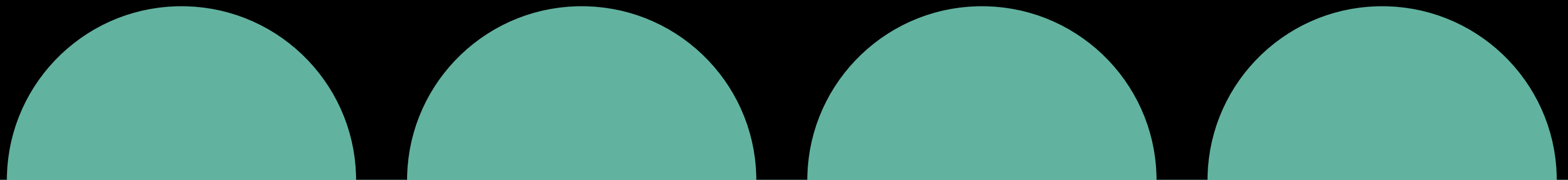



DEEP EVO

Sistema ad incasso per moduli LED
Ampia possibilità di personalizzazioni
Versioni fisse ed orientabili
Installazione in battuta ed a raso
Corpo in pressofusione di alluminio
Riflettore in PC

Recessed system for LED module
Wide range of personalizations
Fixed or adjustable versions
Trim or trimless installation
Die-cast aluminium body
PC reflector

CONFIGURAZIONI
CONFIGURATIONS

INSTALLAZIONE
APPLICATION



FINITURA CORPO
BODY FINISHING



FINITURA RIFLETORE
REFLECTOR FINISHING



ORIENTAMENTO
POSITIONING



*Solo per DEEP_EVO e DEEP_EVO_LESS
*Only available on DEEP_EVO and DEEP_EVO_LESS

OTTICA
BEAM

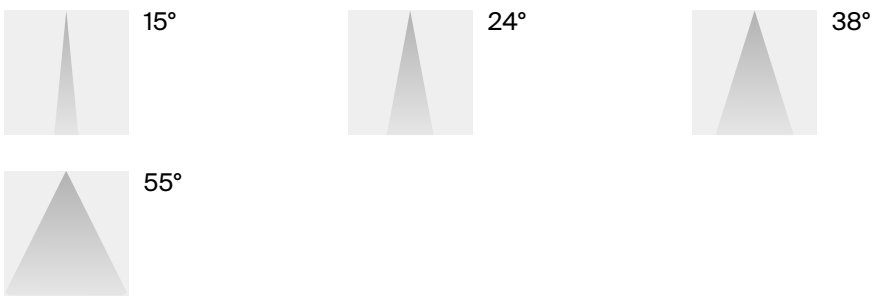

POTENZA
POWER



DRIVER

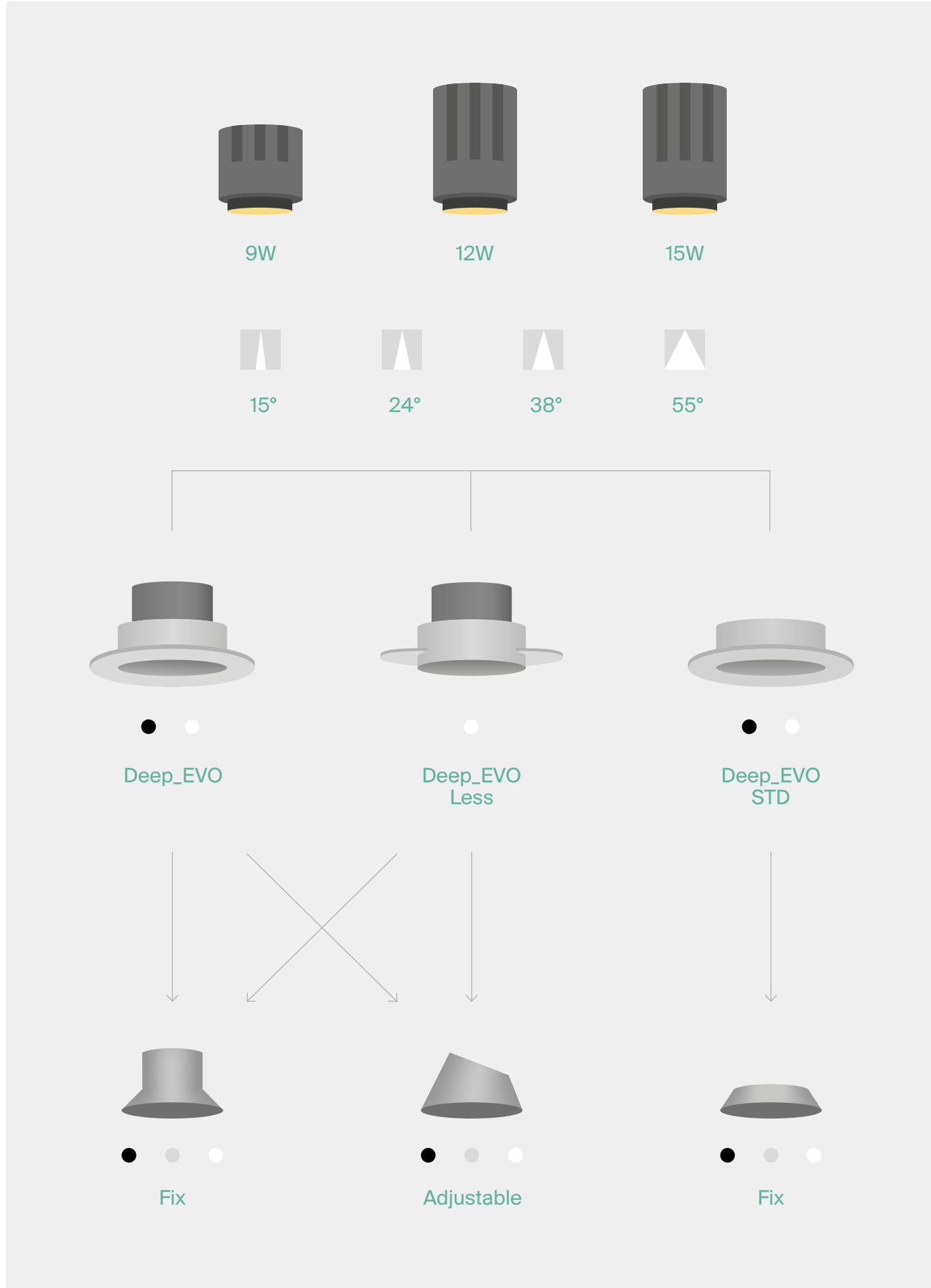



DEEP_EVO FIX

CODE	FINISHING BODY	FINISHING REFLECTOR
71582	Bianco/White	Bianco/White
71583	Bianco/White	Nero/Black
71584	Bianco/White	Silver
71585	Nero/Black	Bianco/White
71586	Nero/Black	Nero/Black
71587	Nero/Black	Silver

INSTALLAZIONE APPLICATION

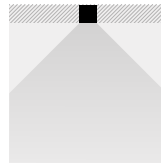

Incasso/Recessed

DISEGNI TECNICI C/ MODULO LED TECHNICAL DRAWING W/ LED MODULE

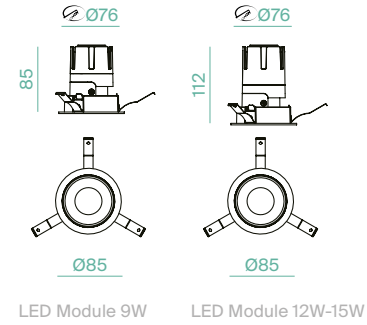

LED Module 9W

LED Module 12W-15W



MODULO LED DEEP_EVO

LED
CRI
PF

Bridgelux
>90
>0.9

CODE	WATT	LUMEN	BEAM	KELVIN	DRIVER	MODE
71606	9W	715	15°	3000K	8-16V 500mA	ON-OFF
71607	9W	725	24°	3000K	8-16V 500mA	ON-OFF
71608	9W	740	38°	3000K	8-16V 500mA	ON-OFF
71609	9W	695	55°	3000K	8-16V 500mA	ON-OFF
71610	12W	1015	15°	3000K	30-42V 300mA	ON-OFF
71611	12W	1055	24°	3000K	30-42V 300mA	ON-OFF
71612	12W	1050	38°	3000K	30-42V 300mA	ON-OFF
71613	12W	1000	55°	3000K	30-42V 300mA	ON-OFF
71614	15W	1150	15°	3000K	30-40V 350mA	ON-OFF
71615	15W	1170	24°	3000K	30-40V 350mA	ON-OFF
71616	15W	1155	38°	3000K	30-40V 350mA	ON-OFF
71617	15W	1110	55°	3000K	30-40V 350mA	ON-OFF
71618	9W	715	15°	3000K	32-45V 200mA	1-10V
71619	9W	725	24°	3000K	32-45V 200mA	1-10V
71620	9W	740	38°	3000K	32-45V 200mA	1-10V
71621	9W	695	55°	3000K	32-45V 200mA	1-10V
71622	12W	1015	15°	3000K	28-40V 300mA	1-10V
71623	12W	1055	24°	3000K	28-40V 300mA	1-10V
71624	12W	1050	38°	3000K	28-40V 300mA	1-10V
71625	12W	1000	55°	3000K	28-40V 300mA	1-10V
71626	15W	1150	15°	3000K	30-43V 350mA	1-10V
71627	15W	1170	24°	3000K	30-43V 350mA	1-10V
71628	15W	1155	38°	3000K	30-43V 350mA	1-10V
71629	15W	1110	55°	3000K	30-43V 350mA	1-10V



ACCESSORI ACCESSORIES



CODE	DESCRIPTION
71575	Filtro honeycomb/Honeycomb filter

COMBINAZIONI COMBINATIONS





DEEP_EVO ADJUSTABLE

CODE	FINISHING BODY	FINISHING REFLECTOR
71588	Bianco/White	Bianco/White
71589	Bianco/White	Nero/Black
71590	Bianco/White	Silver
71591	Nero/Black	Bianco/White
71592	Nero/Black	Nero/Black
71593	Nero/Black	Silver

INSTALLAZIONE APPLICATION

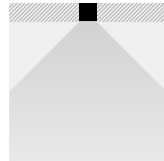

Incasso/Recessed

REGOLAZIONI ADJUSTABILITY



DISEGNI TECNICI C/ MODULO LED TECHNICAL DRAWING W/ LED MODULE

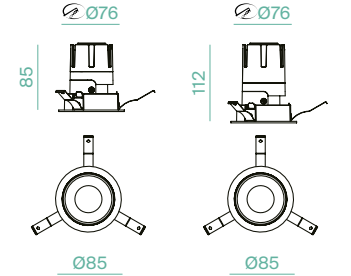

LED Module 9W

LED Module 12W-15W



MODULO LED DEEP_EVO

LED
CRI
PF

Bridgelux
>90
>0.9

CODE	WATT	LUMEN	BEAM	KELVIN	DRIVER	MODE
71606	9W	715	15°	3000K	8-16V 500mA	ON-OFF
71607	9W	725	24°	3000K	8-16V 500mA	ON-OFF
71608	9W	740	38°	3000K	8-16V 500mA	ON-OFF
71609	9W	695	55°	3000K	8-16V 500mA	ON-OFF
71610	12W	1015	15°	3000K	30-42V 300mA	ON-OFF
71611	12W	1055	24°	3000K	30-42V 300mA	ON-OFF
71612	12W	1050	38°	3000K	30-42V 300mA	ON-OFF
71613	12W	1000	55°	3000K	30-42V 300mA	ON-OFF
71614	15W	1150	15°	3000K	30-40V 350mA	ON-OFF
71615	15W	1170	24°	3000K	30-40V 350mA	ON-OFF
71616	15W	1155	38°	3000K	30-40V 350mA	ON-OFF
71617	15W	1110	55°	3000K	30-40V 350mA	ON-OFF
71618	9W	715	15°	3000K	32-45V 200mA	1-10V
71619	9W	725	24°	3000K	32-45V 200mA	1-10V
71620	9W	740	38°	3000K	32-45V 200mA	1-10V
71621	9W	695	55°	3000K	32-45V 200mA	1-10V
71622	12W	1015	15°	3000K	28-40V 300mA	1-10V
71623	12W	1055	24°	3000K	28-40V 300mA	1-10V
71624	12W	1050	38°	3000K	28-40V 300mA	1-10V
71625	12W	1000	55°	3000K	28-40V 300mA	1-10V
71626	15W	1150	15°	3000K	30-43V 350mA	1-10V
71627	15W	1170	24°	3000K	30-43V 350mA	1-10V
71628	15W	1155	38°	3000K	30-43V 350mA	1-10V
71629	15W	1110	55°	3000K	30-43V 350mA	1-10V



ACCESSORI ACCESSORIES



CODE	DESCRIPTION
71575	Filtro honeycomb/Honeycomb filter

COMBINAZIONI COMBINATIONS





DEEP_EVO LESS FIX

CODE	FINISHING BODY	FINISHING REFLECTOR
71594	Bianco/White	Bianco/White
71595	Bianco/White	Nero/Black
71596	Bianco/White	Silver

INSTALLAZIONE APPLICATION

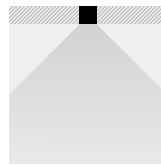

Incasso/Recessed

DISEGNI TECNICI C/ MODULO LED TECHNICAL DRAWING W/ LED MODULE

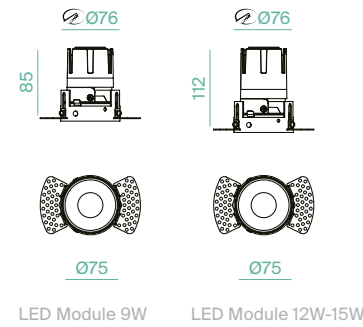

LED Module 9W

LED Module 12W-15W



MODULO LED DEEP_EVO

LED
CRI
PF

Bridgelux
>90
>0.9

CODE	WATT	LUMEN	BEAM	KELVIN	DRIVER	MODE
71606	9W	715	15°	3000K	8-16V 500mA	ON-OFF
71607	9W	725	24°	3000K	8-16V 500mA	ON-OFF
71608	9W	740	38°	3000K	8-16V 500mA	ON-OFF
71609	9W	695	55°	3000K	8-16V 500mA	ON-OFF
71610	12W	1015	15°	3000K	30-42V 300mA	ON-OFF
71611	12W	1055	24°	3000K	30-42V 300mA	ON-OFF
71612	12W	1050	38°	3000K	30-42V 300mA	ON-OFF
71613	12W	1000	55°	3000K	30-42V 300mA	ON-OFF
71614	15W	1150	15°	3000K	30-40V 350mA	ON-OFF
71615	15W	1170	24°	3000K	30-40V 350mA	ON-OFF
71616	15W	1155	38°	3000K	30-40V 350mA	ON-OFF
71617	15W	1110	55°	3000K	30-40V 350mA	ON-OFF
71618	9W	715	15°	3000K	32-45V 200mA	1-10V
71619	9W	725	24°	3000K	32-45V 200mA	1-10V
71620	9W	740	38°	3000K	32-45V 200mA	1-10V
71621	9W	695	55°	3000K	32-45V 200mA	1-10V
71622	12W	1015	15°	3000K	28-40V 300mA	1-10V
71623	12W	1055	24°	3000K	28-40V 300mA	1-10V
71624	12W	1050	38°	3000K	28-40V 300mA	1-10V
71625	12W	1000	55°	3000K	28-40V 300mA	1-10V
71626	15W	1150	15°	3000K	30-43V 350mA	1-10V
71627	15W	1170	24°	3000K	30-43V 350mA	1-10V
71628	15W	1155	38°	3000K	30-43V 350mA	1-10V
71629	15W	1110	55°	3000K	30-43V 350mA	1-10V



ACCESSORI ACCESSORIES



CODE	DESCRIPTION
71575	Filtro honeycomb/Honeycomb filter





DEEP_EVO LESS ADJUSTABLE

CODE	FINISHING BODY	FINISHING REFLECTOR
71597	Bianco/White	Bianco/White
71598	Bianco/White	Nero/Black
71599	Bianco/White	Silver

INSTALLAZIONE APPLICATION

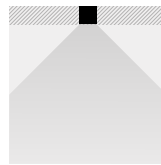

Incasso/Recessed

REGOLAZIONI ADJUSTABILITY



DISEGNI TECNICI C/ MODULO LED TECHNICAL DRAWING W/ LED MODULE

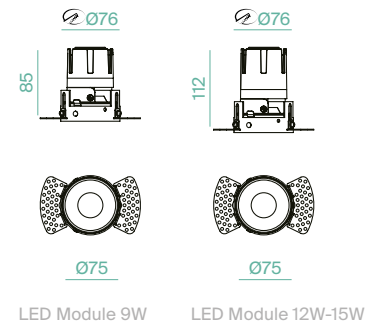

MODULO LED DEEP_EVO

LED
CRI
PF

Bridgelux
>90
>0.9

CODE	WATT	LUMEN	BEAM	KELVIN	DRIVER	MODE
71606	9W	715	15°	3000K	8-16V 500mA	ON-OFF
71607	9W	725	24°	3000K	8-16V 500mA	ON-OFF
71608	9W	740	38°	3000K	8-16V 500mA	ON-OFF
71609	9W	695	55°	3000K	8-16V 500mA	ON-OFF
71610	12W	1015	15°	3000K	30-42V 300mA	ON-OFF
71611	12W	1055	24°	3000K	30-42V 300mA	ON-OFF
71612	12W	1050	38°	3000K	30-42V 300mA	ON-OFF
71613	12W	1000	55°	3000K	30-42V 300mA	ON-OFF
71614	15W	1150	15°	3000K	30-40V 350mA	ON-OFF
71615	15W	1170	24°	3000K	30-40V 350mA	ON-OFF
71616	15W	1155	38°	3000K	30-40V 350mA	ON-OFF
71617	15W	1110	55°	3000K	30-40V 350mA	ON-OFF
71618	9W	715	15°	3000K	32-45V 200mA	1-10V
71619	9W	725	24°	3000K	32-45V 200mA	1-10V
71620	9W	740	38°	3000K	32-45V 200mA	1-10V
71621	9W	695	55°	3000K	32-45V 200mA	1-10V
71622	12W	1015	15°	3000K	28-40V 300mA	1-10V
71623	12W	1055	24°	3000K	28-40V 300mA	1-10V
71624	12W	1050	38°	3000K	28-40V 300mA	1-10V
71625	12W	1000	55°	3000K	28-40V 300mA	1-10V
71626	15W	1150	15°	3000K	30-43V 350mA	1-10V
71627	15W	1170	24°	3000K	30-43V 350mA	1-10V
71628	15W	1155	38°	3000K	30-43V 350mA	1-10V
71629	15W	1110	55°	3000K	30-43V 350mA	1-10V



ACCESSORI ACCESSORIES



CODE	DESCRIPTION
71575	Filtro honeycomb/Honeycomb filter





DEEP_EVO STD

CODE	FINISHING BODY	FINISHING REFLECTOR
71600	Bianco/White	Bianco/White
71601	Bianco/White	Nero/Black
71602	Bianco/White	Silver
71603	Nero/Black	Bianco/White
71604	Nero/Black	Nero/Black
71605	Nero/Black	Silver

INSTALLAZIONE APPLICATION

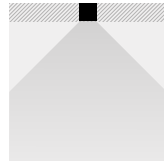

Incasso/Recessed

DISEGNI TECNICI C/ MODULO LED TECHNICAL DRAWING W/ LED MODULE

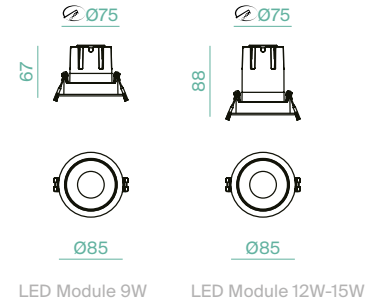

LED Module 9W

LED Module 12W-15W



MODULO LED DEEP_EVO

LED	Bridgelux
CRI	>90
PF	>0.9

CODE	WATT	LUMEN	BEAM	KELVIN	DRIVER	MODE
71606	9W	715	15°	3000K	8-16V 500mA	ON-OFF
71607	9W	725	24°	3000K	8-16V 500mA	ON-OFF
71608	9W	740	38°	3000K	8-16V 500mA	ON-OFF
71609	9W	695	55°	3000K	8-16V 500mA	ON-OFF
71610	12W	1015	15°	3000K	30-42V 300mA	ON-OFF
71611	12W	1055	24°	3000K	30-42V 300mA	ON-OFF
71612	12W	1050	38°	3000K	30-42V 300mA	ON-OFF
71613	12W	1000	55°	3000K	30-42V 300mA	ON-OFF
71614	15W	1150	15°	3000K	30-40V 350mA	ON-OFF
71615	15W	1170	24°	3000K	30-40V 350mA	ON-OFF
71616	15W	1155	38°	3000K	30-40V 350mA	ON-OFF
71617	15W	1110	55°	3000K	30-40V 350mA	ON-OFF
71618	9W	715	15°	3000K	32-45V 200mA	1-10V
71619	9W	725	24°	3000K	32-45V 200mA	1-10V
71620	9W	740	38°	3000K	32-45V 200mA	1-10V
71621	9W	695	55°	3000K	32-45V 200mA	1-10V
71622	12W	1015	15°	3000K	28-40V 300mA	1-10V
71623	12W	1055	24°	3000K	28-40V 300mA	1-10V
71624	12W	1050	38°	3000K	28-40V 300mA	1-10V
71625	12W	1000	55°	3000K	28-40V 300mA	1-10V
71626	15W	1150	15°	3000K	30-43V 350mA	1-10V
71627	15W	1170	24°	3000K	30-43V 350mA	1-10V
71628	15W	1155	38°	3000K	30-43V 350mA	1-10V
71629	15W	1110	55°	3000K	30-43V 350mA	1-10V



ACCESSORI ACCESSORIES



CODE	DESCRIPTION
71575	Filtro honeycomb/Honeycomb filter

COMBINAZIONI COMBINATIONS





FULGOR_IN

Incasso LED integrato
Corpo estraibile ed orientabile
Corpo in alluminio pressofuso verniciato
Driver incluso

Integrated LED downlight
Extractable and adjustable body
Painted die-cast aluminium body
Driver included



FULGOR_IN

LED
CRI >90
PF >0.95

Bridgelux

CODE	FINISHING	WATT	LUMEN	BEAM	KELVIN	DRIVER
41686	Bianco/White	24W	2220	15°	3000	30-42V 600mA
41690	Bianco/White	24W	2280	24°	3000	30-42V 600mA
41682	Bianco/White	24W	2340	38°	3000	30-42V 600mA
41694	Bianco/White	24W	2310	55°	3000	30-42V 600mA
41687	Bianco/White	24W	2400	15°	4000	30-42V 600mA
41691	Bianco/White	24W	2480	24°	4000	30-42V 600mA
41683	Bianco/White	24W	2550	38°	4000	30-42V 600mA
41695	Bianco/White	24W	2510	55°	4000	30-42V 600mA
41688	Nero/Black	24W	2220	15°	3000	30-42V 600mA
41692	Nero/Black	24W	2280	24°	3000	30-42V 600mA
41684	Nero/Black	24W	2340	38°	3000	30-42V 600mA
41696	Nero/Black	24W	2310	55°	3000	30-42V 600mA
41689	Nero/Black	24W	2400	15°	4000	30-42V 600mA
41693	Nero/Black	24W	2480	24°	4000	30-42V 600mA
41685	Nero/Black	24W	2550	38°	4000	30-42V 600mA
41697	Nero/Black	24W	2510	55°	4000	30-42V 600mA

INSTALLAZIONE
APPLICATION

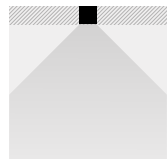

Incasso/Recessed

DISEGNI TECNICI
TECHNICAL DRAWINGS

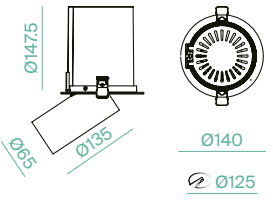

REGOLAZIONI
ADJUSTABILITY



5 GARANZIA WARRANTY LED IP20 CE



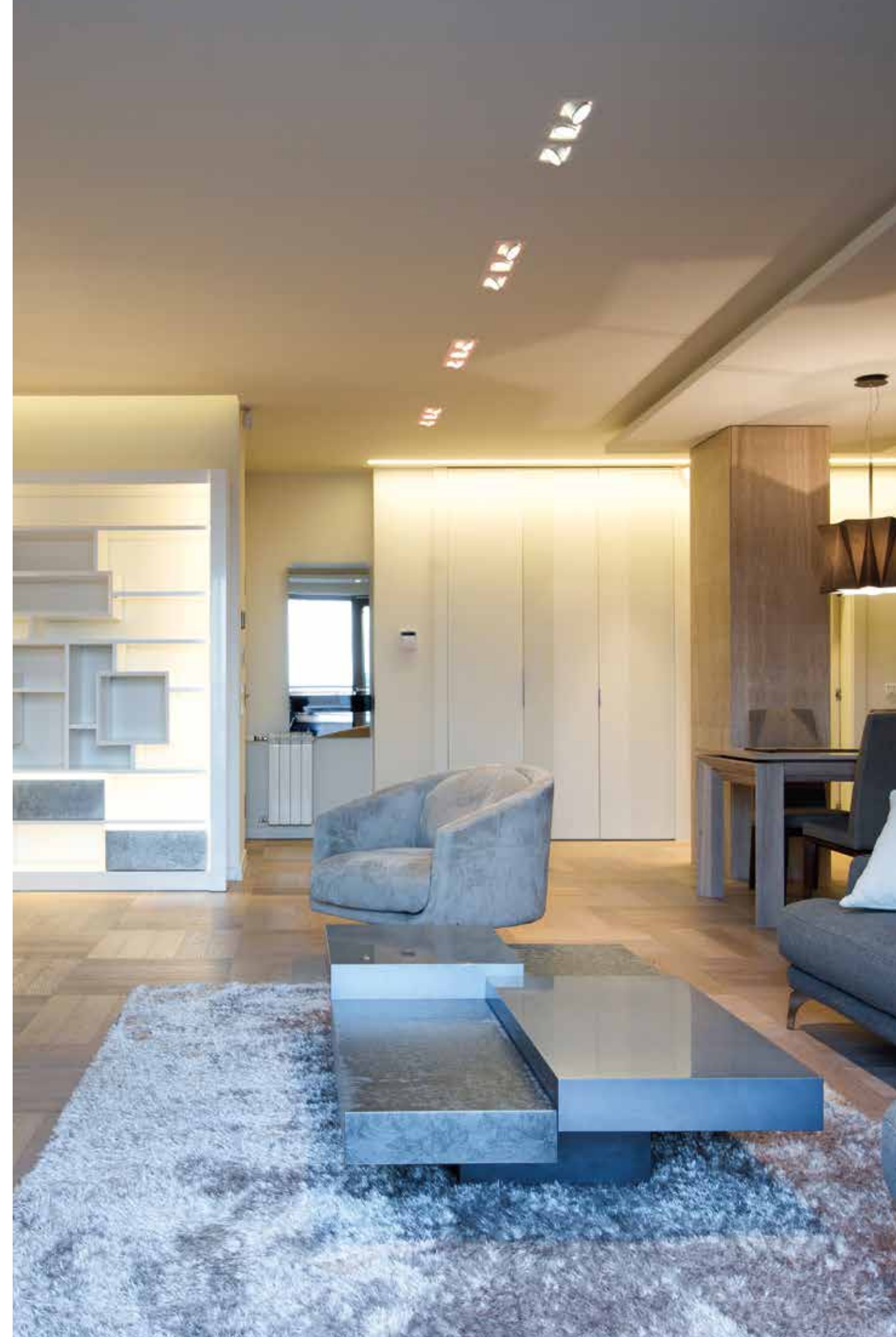

GYMBO QUADRO

Sistema LED integrato
Corpo estraibile ed orientabile
Corpo in alluminio pressofuso verniciato
Riflettore brillantato
Driver dimmerabile incluso
Possibilità di montaggio in serie

Integrated LED system
Extractable and adjustable body
Painted die-cast aluminium body
Multi-faceted reflector
Dimmable driver included
Modular mounting available



GYMBO QUADRO

LED
CRI
PF

CREE
82
0.95

CODE	FINISHING	WATT	LUMEN	BEAM	KELVIN	DRIVER	MODE
42585	Bianco/White	22W	2050	60°	3000K	530mA 36V	1-10V
42586	Bianco/White	22W	2070	60°	4000K	530mA 36V	1-10V
42583	Bianco/White	43W	4100	60°	3000K	1050mA 36V	1-10V
42584	Bianco/White	43W	4150	60°	4000K	1050mA 36V	1-10V
42601	Bianco/White	22W	2050	38°	3000K	530mA 36V	1-10V
42602	Bianco/White	22W	2070	38°	4000K	530mA 36V	1-10V
42599	Bianco/White	43W	4100	38°	3000K	1050mA 36V	1-10V
42600	Bianco/White	43W	4150	38°	4000K	1050mA 36V	1-10V
42593	Bianco/White	22W	2050	24°	3000K	530mA 36V	1-10V
42594	Bianco/White	22W	2070	24°	4000K	530mA 36V	1-10V
42591	Bianco/White	43W	4100	24°	3000K	1050mA 36V	1-10V
42592	Bianco/White	43W	4150	24°	4000K	1050mA 36V	1-10V

INSTALLAZIONE APPLICATION

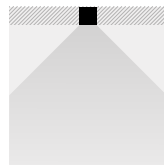

Incasso/Recessed

DISEGNI TECNICI TECHNICAL DRAWINGS

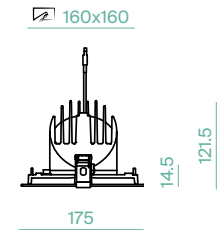

REGOLAZIONI ADJUSTABILITY



35°
90°



ACCESSORI ACCESSORIES



CODE	DESCRIPTION
40313	Staffe di collegamento (2 pz) / Connection rods (2 pcs)

DISEGNI TECNICI TECHNICAL DRAWINGS

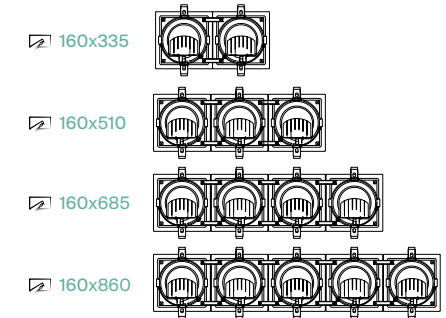



GYMBO TONDO

LED
CRI
PF

CREE
82
0.95

CODE	FINISHING	WATT	LUMEN	BEAM	KELVIN	DRIVER	MODE
42581	Bianco/White	22W	2050	60°	3000K	530mA 36V	1-10V
42582	Bianco/White	22W	2070	60°	4000K	530mA 36V	1-10V
42579	Bianco/White	43W	4100	60°	3000K	1050mA 36V	1-10V
42580	Bianco/White	43W	4150	60°	4000K	1050mA 36V	1-10V
42597	Bianco/White	22W	2050	38°	3000K	530mA 36V	1-10V
42598	Bianco/White	22W	2070	38°	4000K	530mA 36V	1-10V
42595	Bianco/White	43W	4100	38°	3000K	1050mA 36V	1-10V
42596	Bianco/White	43W	4150	38°	4000K	1050mA 36V	1-10V
42589	Bianco/White	22W	2050	24°	3000K	530mA 36V	1-10V
42590	Bianco/White	22W	2070	24°	4000K	530mA 36V	1-10V
42587	Bianco/White	43W	4100	24°	3000K	1050mA 36V	1-10V
42588	Bianco/White	43W	4150	24°	4000K	1050mA 36V	1-10V

INSTALLAZIONE APPLICATION

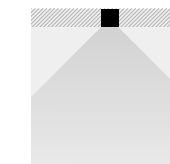

Incasso/Recessed

DISEGNI TECNICI TECHNICAL DRAWINGS

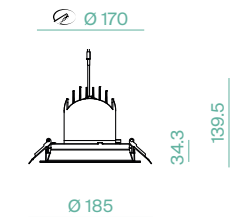

REGOLAZIONI ADJUSTABILITY

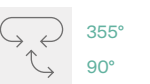

GYMBO TONDO

Incasso LED integrato
Corpo estraibile ed orientabile
Corpo in alluminio pressofuso verniciato
Riflettore brillantato
Driver dimmerabile incluso

Integrated LED downlight
Extractable and adjustable body
Painted die-cast aluminium body
Multi-faceted reflector
Dimmable driver included





PUNTO

Incasso LED con cornice minimale
Corpo in alluminio pressofuso verniciato
Riflettore colorato disponibile in quattro varianti
Driver non incluso

Recessed fitting LED light with minimal frame
Painted die-cast aluminium body
Inner reflector available in 4 colors
Driver not included

CONFIGURAZIONI
CONFIGURATIONS

FINITURA CORPO
BODY FINISHING



Bianco
White



Nero
Black

FINITURA RIFLETTORE
REFLECTOR FINISHING

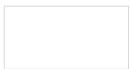

Bianco
White



Nero
Black



Argento
Silver



Oro
Gold

DRIVER



ON/OFF



Dimmerabile



Riflettore nero/Black reflector



Riflettore bianco/White reflector



Riflettore argento/Silver reflector



Riflettore oro/Golden reflector



PUNTO

LED
CRI
CREE
90

CODE	FINISHING BODY	FINISHING REFLECTOR	WATT	LUMEN	BEAM	KELVIN
42686	Bianco/White	Bianco/White	1,6W	100	30°	3000K
42687	Bianco/White	Argento/Silver	1,6W	100	30°	3000K
42688	Bianco/White	Oro/Gold	1,6W	100	30°	3000K
42689	Bianco/White	Nero/Black	1,6W	100	30°	3000K
42693	Nero/Black	Bianco/White	1,6W	100	30°	3000K
42691	Nero/Black	Argento/Silver	1,6W	100	30°	3000K
42692	Nero/Black	Oro/Gold	1,6W	100	30°	3000K
42690	Nero/Black	Nero/Black	1,6W	100	30°	3000K

INSTALLAZIONE APPLICATION

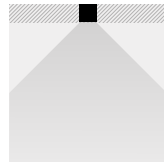

Incasso/Recessed

DISEGNI TECNICI TECHNICAL DRAWINGS

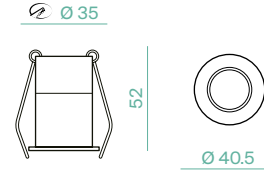

PUNTO L

LED
CRI
Citizen
90

CODE	FINISHING BODY	FINISHING REFLECTOR	WATT	LUMEN	BEAM	KELVIN
42694	Bianco/White	Bianco/White	6W	400	30°	3000K
42695	Bianco/White	Argento/Silver	6W	400	30°	3000K
42696	Bianco/White	Oro/Gold	6W	400	30°	3000K
42697	Bianco/White	Nero/Black	6W	400	30°	3000K
42701	Nero/Black	Bianco/White	6W	400	30°	3000K
42699	Nero/Black	Argento/Silver	6W	400	30°	3000K
42700	Nero/Black	Oro/Gold	6W	400	30°	3000K
42698	Nero/Black	Nero/Black	6W	400	30°	3000K

INSTALLAZIONE APPLICATION



Incasso/Recessed

DISEGNI TECNICI TECHNICAL DRAWINGS

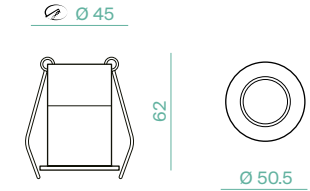

DRIVER

CODE	VOLTAGE	CURRENT	PF	SIZE	DIMMABLE
42702	3-6V	700mA	0.9	38x22x28	TRIAC Dimming
42703	2.5-8V	500mA	>0.5	42x30x20	ON-OFF



DRIVER

CODE	VOLTAGE	CURRENT	PF	SIZE	DIMMABLE
42704	13-26V	350mA	0.95	110x40x23	TRIAC Dimming
42705	9-18V	350mA	0.95	85x40x23	ON-OFF



OCCHIO

Incasso LED integrato fisso e basculante
Corpo in pressofusione di alluminio
Riflettore brillantato
Schermo in PC trasparente
Plug-in driver escluso

Fixed and adjustable LED downlight
Die-cast aluminium body
Multi-faceted reflector
Transparent PC diffuser
Plug-in driver not included



41063 - 41064



41065 - 41066

OCCHIO

LED
CRI >90 Epistar

CODE	FINISHING	WATT	LUMEN	BEAM	KELVIN
41063	Bianco/White	3,5W	250	60°	3000K
41064	Nero/Black	3,5W	250	60°	3000K
41065	Bianco/White	3,5W	250	60°	3000K
41066	Nero/Black	3,5W	250	60°	3000K

INSTALLAZIONE APPLICATION

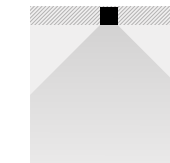

Incasso/Recessed

DISEGNI TECNICI TECHNICAL DRAWINGS

Ø 34



Ø 42

41063
41064

Ø 46

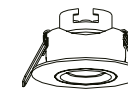

Ø 52

41065
41066

REGOLAZIONI ADJUSTABILITY



DRIVER

CODE	VOLTAGE	CURRENT	PF	SIZE	DIMMABLE
12557	6-12V	300mA	>0.5	37x30x20	ON-OFF
12556	6-12V	300mA	>0.5	40x32x20	TRIAC Dimming



Fix: IP44/20 Adj: IP20



BLITZ

42650 - 42651



42652 - 42653

CODE	FINISHING	DESCRIPTION
42650	Bianco/White	Cornice tonda da incasso per Hyper Dicro/ Recessed round frame for Hyper Dicro
42651	Nero/Black	Cornice tonda da incasso per Hyper Dicro/ Recessed round frame for Hyper Dicro
42652	Bianco/White	Cornice quadrata da incasso per Hyper Dicro/ Recessedsquare frame for Hyper Dicro
42653	Nero/Black	Cornice quadrata da incasso per Hyper Dicro/ Recessedsquare frame for Hyper Dicro

INSTALLAZIONE
APPLICATION

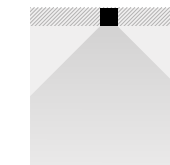

Incasso/Recessed

DISEGNI TECNICI
TECHNICAL DRAWINGS

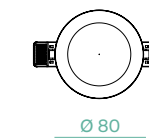

42650
42651

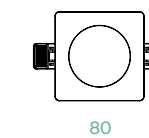
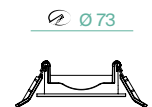

42652
42653

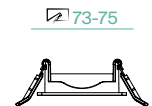

HYPER DICRO + BLITZ

Moduli dicroici ad alte prestazioni con indice resa cromatica >90
Cornici in alluminio pressofuso verniciato,
IP65 per installazione in controsoffitto
Driver ON/OFF, 1-10V o Dali

MR-16 high performance modules with CRI >90
IP65 die-cast aluminium frames
for recessed ceiling installation
ON/OFF, 1-10V or Dali driver



LOGICA



HYPER DICRO

LED
CRI
CREE
>90

CODE	FINISHING	WATT	LUMEN	BEAM	KELVIN
42638	Alluminio/ Aluminium	8.5W	533	38°	2700K
42639	Alluminio/ Aluminium	8.5W	574	38°	3000K
42640	Alluminio/ Aluminium	8.5W	615	38°	4000K

INSTALLAZIONE APPLICATION

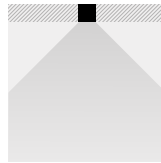

Incasso/Recessed

DISEGNI TECNICI TECHNICAL DRAWINGS

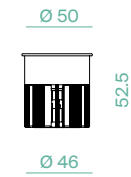

Ø 46



HYPER DICRO

LED
CRI
CREE
>90

CODE	FINISHING	WATT	LUMEN	BEAM	KELVIN
42644	Alluminio/ Aluminium	13W	738	38°	2700K
42645	Alluminio/ Aluminium	13W	820	38°	3000K
42646	Alluminio/ Aluminium	13W	902	38°	4000K

INSTALLAZIONE APPLICATION

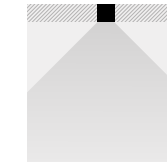

Incasso/Recessed

DISEGNI TECNICI TECHNICAL DRAWINGS

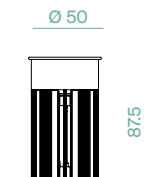

Ø 46

DRIVER

CODE	VOLTAGE	CURRENT	PF	SIZE	MODE
42641	30-42V	180mA	>0.5	95x45x26	ON-OFF
42642	49V	190mA	>0.5	148x50x32	DALI
42643	49V	190mA	>0.5	148x50x32	1-10V



DRIVER

CODE	VOLTAGE	CURRENT	PF	SIZE	MODE
42647	30-42V	280mA	>0.5	92x45x26	ON-OFF
42648	47V	280mA	>0.5	148x50x32	DALI
42649	47V	280mA	>0.5	148x50x32	1-10V





RADIANTE

Incasso LED integrato basculante ottica arretrata
Corpo in alluminio pressofuso verniciato
Riflettore brillantato
Driver dimmerabile incluso (TRIAC)

Adjustable deep-set recessed APPLICATION
with built-in LED
Painted die-cast aluminium body
Multi-faceted reflector
Dimmtable driver included (TRIAC)





RADIANTE 14W

LED
CRI
PF

Epistar
>80
0.88

CODE	FINISHING	WATT	LUMEN	BEAM	KELVIN	DRIVER	MODE
41573	Bianco / White	14W	1152	60°	3000K	300mA 43V	TRIAC Dimming
41624	Nero / Black	14W	1152	60°	3000K	300mA 43V	TRIAC Dimming
41574	Bianco / White	14W	1243	60°	4000K	300mA 43V	TRIAC Dimming
41625	Nero / Black	14W	1243	60°	4000K	300mA 43V	TRIAC Dimming
41587	Bianco / White	14W	1152	24°	3000K	300mA 43V	TRIAC Dimming
41632	Nero / Black	14W	1152	24°	3000K	300mA 43V	TRIAC Dimming
41588	Bianco / White	14W	1243	24°	4000K	300mA 43V	TRIAC Dimming
41633	Nero / Black	14W	1243	24°	4000K	300mA 43V	TRIAC Dimming

INSTALLAZIONE APPLICATION

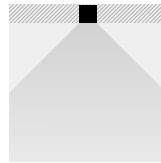

Incasso/Recessed

DISEGNI TECNICI TECHNICAL DRAWINGS

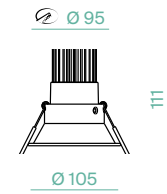

REGOLAZIONI ADJUSTABILITY



RADIANTE 17W

LED
CRI
PF

Epistar
>80
0.88

CODE	FINISHING	WATT	LUMEN	BEAM	KELVIN	DRIVER	MODE
41575	Bianco / White	17W	1320	60°	3000K	350mA 43V	TRIAC Dimming
41626	Nero / Black	17W	1320	60°	3000K	350mA 43V	TRIAC Dimming
41576	Bianco / White	17W	1394	60°	4000K	350mA 43V	TRIAC Dimming
41627	Nero / Black	17W	1394	60°	4000K	350mA 43V	TRIAC Dimming
41589	Bianco / White	17W	1320	24°	3000K	350mA 43V	TRIAC Dimming
41634	Nero / Black	17W	1320	24°	3000K	350mA 43V	TRIAC Dimming
41590	Bianco / White	17W	1394	24°	4000K	350mA 43V	TRIAC Dimming
41635	Nero / Black	17W	1394	24°	4000K	350mA 43V	TRIAC Dimming

INSTALLAZIONE APPLICATION

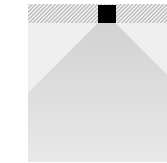

Incasso/Recessed

DISEGNI TECNICI TECHNICAL DRAWINGS

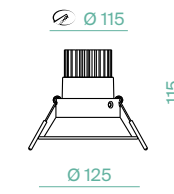

REGOLAZIONI ADJUSTABILITY



ACCESSORI ACCESSORIES

CODE	DESCRIPTION	EFFICIENCY	WAT
12551	Gruppo emergenza/Emergency unit	30% - 90 MIN.	MAX 40W

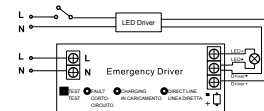
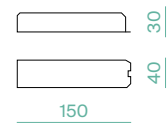

ACCESSORI ACCESSORIES

CODE	DESCRIPTION	EFFICIENCY	WAT
12551	Gruppo emergenza/Emergency unit	30% - 90 MIN.	MAX 40W

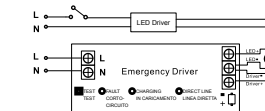
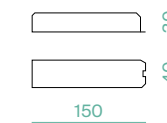



RADIANTE 20W

LED
CRI
PF
Epistar
>80
0.88

CODE	FINISHING	WATT	LUMEN	BEAM	KELVIN	DRIVER	MODE
41577	Bianco / White	20W	1891	60°	3000K	500mA 50V	TRIAC Dimming
41628	Nero / Black	20W	1891	60°	3000K	500mA 50V	TRIAC Dimming
41578	Bianco / White	20W	1994	60°	4000K	500mA 50V	TRIAC Dimming
41629	Nero / Black	20W	1994	60°	4000K	500mA 50V	TRIAC Dimming
41591	Bianco / White	20W	1891	24°	3000K	500mA 50V	TRIAC Dimming
41636	Nero / Black	20W	1891	24°	3000K	500mA 50V	TRIAC Dimming
41592	Bianco / White	20W	1994	24°	4000K	500mA 50V	TRIAC Dimming
41637	Nero / Black	20W	1994	24°	4000K	500mA 50V	TRIAC Dimming

INSTALLAZIONE APPLICATION

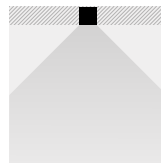

Incasso/Recessed

DISEGNI TECNICI TECHNICAL DRAWINGS

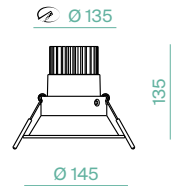

REGOLAZIONI ADJUSTABILITY



RADIANTE 30W

LED
CRI
PF
Epistar
>80
0.88

CODE	FINISHING	WATT	LUMEN	BEAM	KELVIN	DRIVER	MODE
41579	Bianco / White	30W	2503	60°	3000K	700mA 42V	TRIAC Dimming
41630	Nero / Black	30W	2503	60°	3000K	700mA 42V	TRIAC Dimming
41580	Bianco / White	30W	2609	60°	4000K	700mA 42V	TRIAC Dimming
41631	Nero / Black	30W	2609	60°	4000K	700mA 42V	TRIAC Dimming
41593	Bianco / White	30W	2503	24°	3000K	700mA 42V	TRIAC Dimming
41638	Nero / Black	30W	2503	24°	3000K	700mA 42V	TRIAC Dimming
41594	Bianco / White	30W	2609	24°	4000K	700mA 42V	TRIAC Dimming
41639	Nero / Black	30W	2609	24°	4000K	700mA 42V	TRIAC Dimming

INSTALLAZIONE APPLICATION

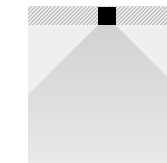

Incasso/Recessed

DISEGNI TECNICI TECHNICAL DRAWINGS

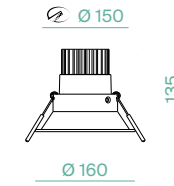

REGOLAZIONI ADJUSTABILITY



ACCESSORI ACCESSORIES

CODE	DESCRIPTION	EFFICIENCY	WAT
12551	Gruppo emergenza/Emergency unit	30% - 90 MIN.	MAX 40W

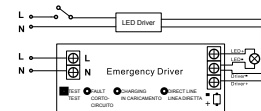
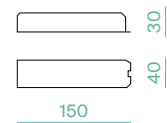

ACCESSORI ACCESSORIES

CODE	DESCRIPTION	EFFICIENCY	WAT
12551	Gruppo emergenza/Emergency unit	30% - 90 MIN.	MAX 40W

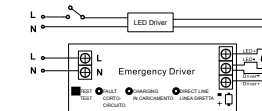
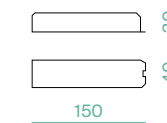



BILUCE

LED
CRI >80
PF 0.5

CODE	FINISHING	WATT	LUMEN	BEAM	KELVIN	DRIVER
41581	Bianco / White	9W+3W	580+100	38°	3000K	200mA/25-42V 300mA10-20V
41582	Bianco / White	9W+3W	610+105	38°	4000K	200mA/25-42V 300mA10-20V
41583	Bianco / White	15W+5W	1050+230	38°	3000K	350mA/25-38V 300mA10-20V
41584	Bianco / White	15W+5W	1100+245	38°	4000K	350mA/25-38V 300mA10-20V

INSTALLAZIONE APPLICATION

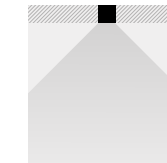

Incasso/Recessed

DISEGNI TECNICI TECHNICAL DRAWINGS

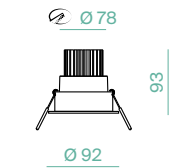

41581
41582

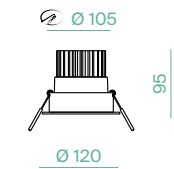

41583
41584

ACCESSORI ACCESSORIES

CODE	DESCRIPTION	EFFICIENCY	WAT
12552	Gruppo emergenza/Emergency unit	30% - 90 MIN.	MAX 9W

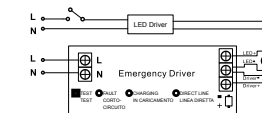
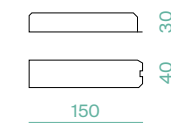

BILUCE

Incasso LED integrato biemissione
Gestione separata delle emissioni
Corpo in alluminio pressofuso verniciato
Riflettore brillantato
Drivers inclusi

Built-in LED downlight with double lighting source
Separate control of the two lighting sources
Painted die-cast aluminium body
Multi-faceted reflector
Drivers included



LUCE POLIVALENTE

Adatto in tutte quelle situazioni in cui la gestione separata delle accensioni incontra l'esigenza di avere luce di presenza, luce notturna, luce d'emergenza.

MULTI-PURPOSE LIGHT

Suitable for all those applications where the separate management of switches is required: courtesy light, night light, emergency light.



MINI

Incasso LED integrato in pressofusione
di alluminio verniciato
Driver non incluso

Built-in LED downlight
Painted die-cast aluminium body
Driver not included



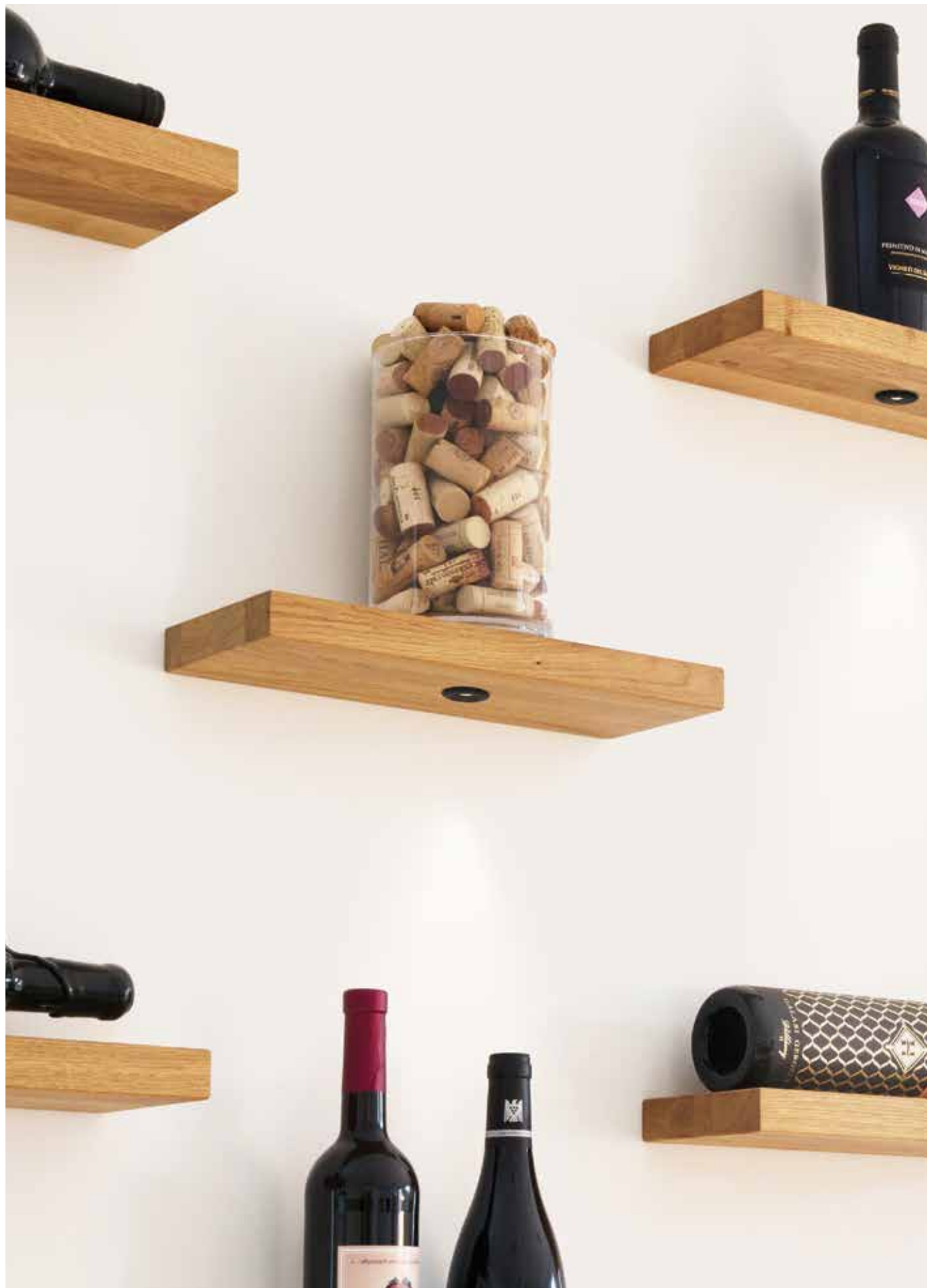

Mini 105 nero/ Mini 105 black

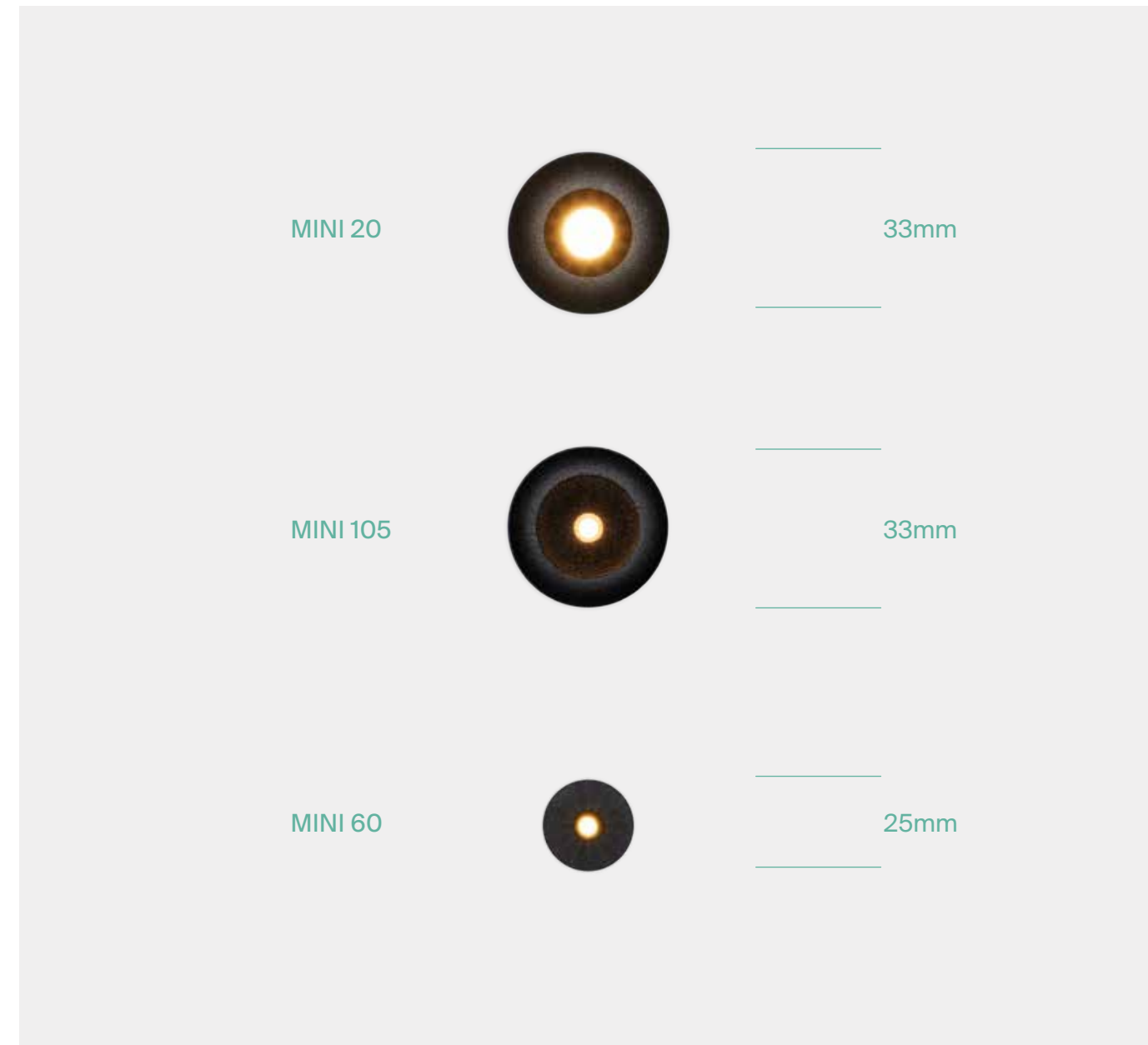

**MINIMO INGOMBRO,
MASSIMA RESA**

La serie Mini vanta dimensioni ridottissime e diversi angoli di luce per quelle situazioni in cui è necessario porre l'accento su certi oggetti o aree dell'ambiente.

**MINIMUM SIZE,
MAXIMUM PERFORMANCE**

Mini series is characterized by small dimensions and different beam angles which are ideal as accent lighting on particular objects or as dot lighting in some areas of the room.



MINI 20

LED
CRI
OSRAM
>80

CODE	FINISHING	WATT	LUMEN	BEAM	KELVIN
42737	Bianco/White	1.2W	92	20°	3000K
42738	Nero/Black	1.2W	92	20°	3000K

INSTALLAZIONE APPLICATION

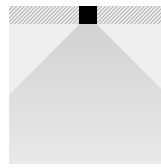

Incasso/Recessed

DISEGNI TECNICI TECHNICAL DRAWINGS

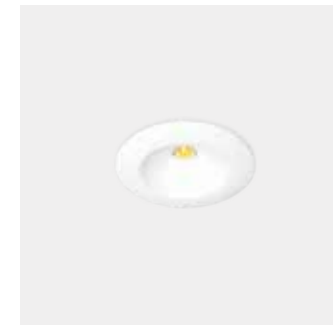
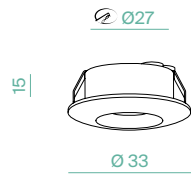

MINI 105

LED
CRI
OSRAM
>80

CODE	FINISHING	WATT	LUMEN	BEAM	KELVIN
42739	Bianco/White	1.2W	71	105°	3000K
42740	Nero/Black	1.2W	71	105°	3000K

INSTALLAZIONE APPLICATION

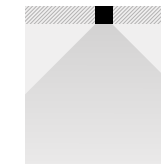

Incasso/Recessed

DISEGNI TECNICI TECHNICAL DRAWINGS

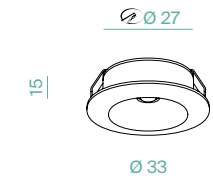

DRIVER

CODE	VOLTAGE	CURRENT	PF	SIZE	DIMMABLE
42743	2-5V	350mA	0.5	53x31x21	ON-OFF



DRIVER

CODE	VOLTAGE	CURRENT	PF	SIZE	DIMMABLE
42743	2-5V	350mA	0.5	53x31x21	ON-OFF





**MINI
60**

LED
CRI OSRAM
>80

CODE	FINISHING	WATT	LUMEN	BEAM	KELVIN
42741	Bianco/White	1.2W	94	60°	3000K
42742	Nero/Black	1.2W	94	60°	3000K

**INSTALLAZIONE
APPLICATION**



Incasso/Recessed

**DISEGNI TECNICI
TECHNICAL DRAWINGS**

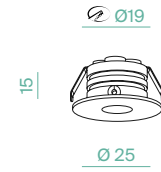

**Presenza minimale
e discreta
per l'inserimento
di accenti di luce.**
Minimal and discreet
presence to add
light accents.

DRIVER

CODE	VOLTAGE	CURRENT	PF	SIZE	DIMMABLE
42743	2-5V	350mA	0.5	53x31x21	ON-OFF



ZEUS

Incasso LED integrato in pressofusione di alluminio verniciato
Driver non incluso

Built-in LED downlight
Painted die-cast aluminium body
Driver not included



ZEUS

LED
CRI

EPISTAR
>80

CODE	FINISHING	WATT	LUMEN	BEAM	KELVIN
42745	Bianco/White	3W	285	90°	3000K
42744	Nero/Black	3W	285	90°	3000K

INSTALLAZIONE APPLICATION

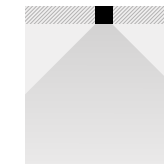

Incasso/Recessed

DISEGNI TECNICI TECHNICAL DRAWINGS

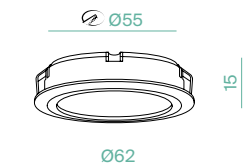

DRIVER

CODE	VOLTAGE	CURRENT	PF	SIZE	DIMMABLE
42746	6-12V	350mA	>0.5	40x30x20	ON-OFF





ACQUA COB

LED
CRI >80
PF >0.5

Ledteen

>80

>0.5

CODE	FINISHING	WATT	LUMEN	BEAM	KELVIN
40430	Bianco / White	8W	720	60°	3000K

INSTALLAZIONE APPLICATION

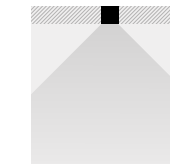

Incasso/Recessed

DISEGNI TECNICI TECHNICAL DRAWINGS

Ø 75

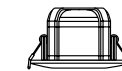

55

Ø 90

AQUA COB

Incasso LED integrato stagno
Corpo in alluminio pressofuso verniciato
Optica in PC trasparente
Driver integrato

Water-proof recessed APPLICATION with built-in LED
Painted die-cast aluminium body
Transparent PC screen
Built-in driver





ACQUA SMD

LED Cree
CRI >80
PF >0.5

CODE	FINISHING	WATT	LUMEN	BEAM	KELVIN
40429	Bianco / White	6W	400	110°	3000K

INSTALLAZIONE APPLICATION

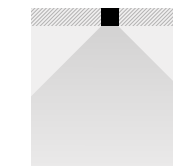

Incasso/Recessed

DISEGNI TECNICI TECHNICAL DRAWINGS

Ø 75

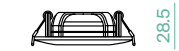

Ø 90

AQUA SMD

Incasso LED integrato stagno
Corpo in alluminio pressofuso verniciato
Optica in PC opale
Driver integrato

Water-proof recessed APPLICATION with built-in LED
Painted die-cast aluminium body
Opal PC screen
Built-in driver





FRAME

Lampadina esclusa / Bulb not included

CODE	FINISHING	BASE
53421/GU10	Bianco / White	GU10 230V 50/60Hz~ Max.50W
53426/GU10	Nero / Black	GU10 230V 50/60Hz~ Max.50W

INSTALLAZIONE APPLICATION

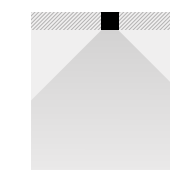

Incasso/Recessed

DISEGNI TECNICI TECHNICAL DRAWINGS

106x106

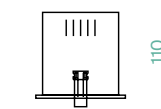

118x118

REGOLAZIONI ADJUSTABILITY



±45°



FRAME

Lampadina esclusa / Bulb not included

CODE	FINISHING	BASE
53423/GU10	Bianco / White	GU10 230V 50/60Hz~ Max.2x50W
53427/GU10	Nero / Black	GU10 230V 50/60Hz~ Max.2x50W

INSTALLAZIONE APPLICATION

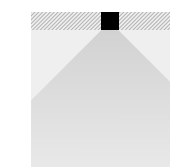

Incasso/Recessed

DISEGNI TECNICI TECHNICAL DRAWINGS

211x106

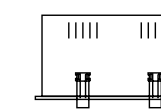

223x118

REGOLAZIONI ADJUSTABILITY



±45°



FRAME

Incasso regolabile per dicroiche e AR111
Corpo in acciaio verniciato
Cornice in estrusione di alluminio verniciato
Lampada non inclusa

Incasso regolabile per dicroiche e AR111
Corpo in acciaio verniciato
Cornice in estrusione di alluminio verniciato
Lampada non inclusa



FRAME

Lampadina esclusa / Bulb not included

CODE	FINISHING	BASE
53425/GU10	Bianco / White	GU10 230V 50/60Hz~ Max.3x50W
53428/GU10	Nero / Black	GU10 230V 50/60Hz~ Max.3x50W

INSTALLAZIONE APPLICATION

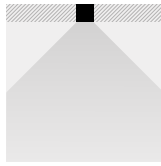

Incasso/Recessed

DISEGNI TECNICI TECHNICAL DRAWINGS

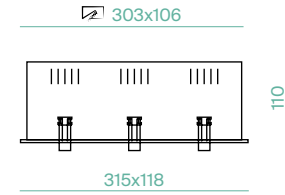

REGOLAZIONI ADJUSTABILITY



FRAME 111

Lampadina esclusa / Bulb not included

CODE	FINISHING	BASE
53433/GU10	Bianco / White	AR111 GU10 230V 50/60Hz~ Max.50W
53429/GU10	Nero / Black	AR111 GU10 230V 50/60Hz~ Max.50W

INSTALLAZIONE APPLICATION

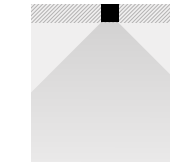

Incasso/Recessed

DISEGNI TECNICI TECHNICAL DRAWINGS

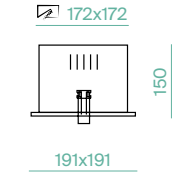

REGOLAZIONI ADJUSTABILITY



FRAME 111

Lampadina esclusa / Bulb not included

CODE	FINISHING	BASE
53435/GU10	Bianco / White	AR111 GU10 230V 50/60Hz~ Max.2x50W
53430/GU10	Nero / Black	AR111 GU10 230V 50/60Hz~ Max.2x50W

INSTALLAZIONE APPLICATION

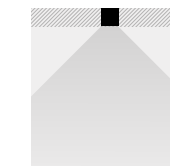

Incasso/Recessed

DISEGNI TECNICI TECHNICAL DRAWINGS

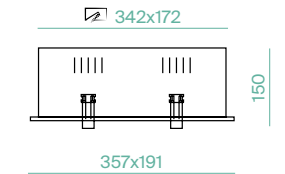

REGOLAZIONI ADJUSTABILITY





FRAME 111

Lampadina esclusa / Bulb not included

CODE	FINISHING	BASE
53437/GU10	Bianco / White	AR111 GU10 230V 50/60Hz~ Max.3x50W
53431/GU10	Nero / Black	AR111 GU10 230V 50/60Hz~ Max.3x50W

**INSTALLAZIONE
APPLICATION**

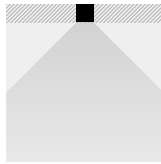

Incasso/Recessed

**DISEGNI TECNICI
TECHNICAL DRAWINGS**

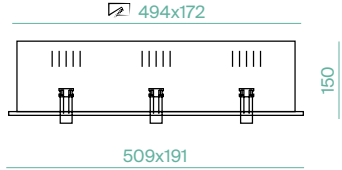

**REGOLAZIONI
ADJUSTABILITY**



LED IP20 230V 50/60Hz CE



FRAMELESS

Lampadina esclusa / Bulb not included

CODE	FINISHING	BASE
53448B/GU10	Bianco / White	GU10 230V 50/60Hz~ Max.50W
53448/GU10	Nero / Black	GU10 230V 50/60Hz~ Max.50W

INSTALLAZIONE APPLICATION



Incasso/Recessed

DISEGNI TECNICI TECHNICAL DRAWINGS

103x103

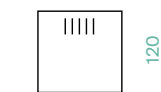

97x97

120

REGOLAZIONI ADJUSTABILITY



FRAMELESS

Lampadina esclusa / Bulb not included

CODE	FINISHING	BASE
53449B/GU10	Bianco / White	GU10 230V 50/60Hz~ Max.2x50W
53449/GU10	Nero / Black	GU10 230V 50/60Hz~ Max.2x50W

INSTALLAZIONE APPLICATION

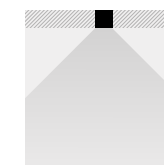

Incasso/Recessed

DISEGNI TECNICI TECHNICAL DRAWINGS

208x103



202x97

120

REGOLAZIONI ADJUSTABILITY



FRAMELESS

Incasso a scomparsa regolabile
per dicroiche e AR111
Corpo in acciaio verniciato
Lampada non inclusa

Adjustable hidden recessed APPLICATION
for MR-16 and AR111
Painted steel body
Bulb not included





FRAMELESS

Lampadina esclusa / Bulb not included

CODE	FINISHING	BASE
53450B/GU10	Bianco / White	GU10 230V 50/60Hz~ Max.3x50W
53450/GU10	Nero / Black	GU10 230V 50/60Hz~ Max.3x50W

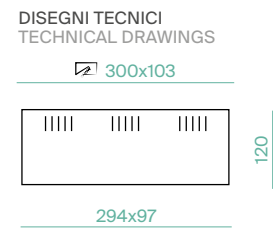
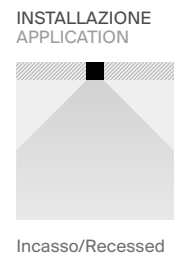

FRAMELESS 111

Lampadina esclusa / Bulb not included

CODE	FINISHING	BASE
53454B/GU10	Bianco / White	AR111 GU10 230V 50/60Hz~ Max.50W
53454/GU10	Nero / Black	AR111 GU10 230V 50/60Hz~ Max.50W

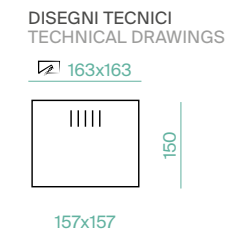
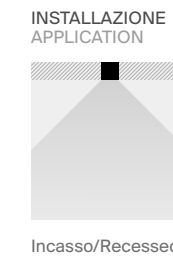

FRAMELESS 111

Lampadina esclusa / Bulb not included

CODE	FINISHING	BASE
53455B/GU10	Bianco / White	AR111 GU10 230V 50/60Hz~ Max.2x50W
53455/GU10	Nero / Black	AR111 GU10 230V 50/60Hz~ Max.2x50W

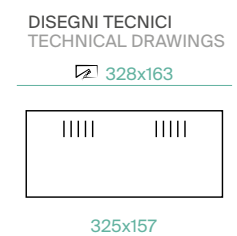
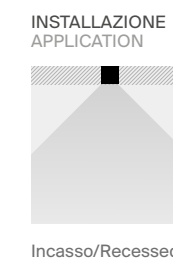



FRAMELESS 111

Lampadina esclusa / Bulb not included

CODE	FINISHING	BASE
53456B/GU10	Bianco / White	AR111 GU10 230V 50/60Hz~ Max.3x50W
53456/GU10	Nero / Black	AR111 GU10 230V 50/60Hz~ Max.3x50W

INSTALLAZIONE APPLICATION

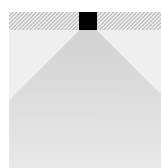

Incasso/Recessed

REGOLAZIONI ADJUSTABILITY



±45°

DISEGNI TECNICI TECHNICAL DRAWINGS

481x163



150

477x157



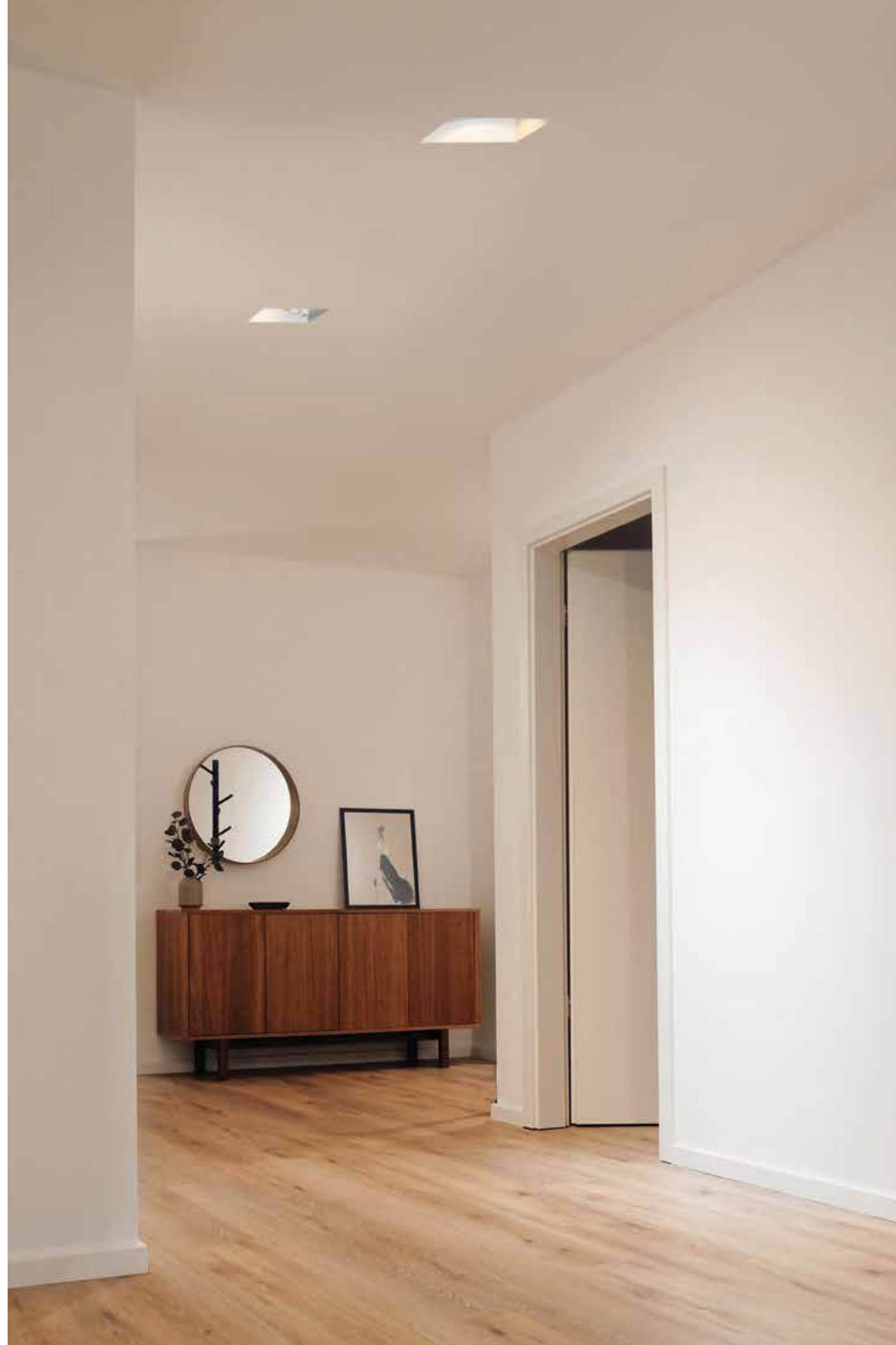

WIZARD

Incasso con montaggio a raso per dicriche e AR111
Corpo in acciaio verniciato
Lampada orientabile
Lampada non inclusa

Recessed fitting for MR-16 and AR111
Painted steel body
Adjustable lamp
Bulb not included

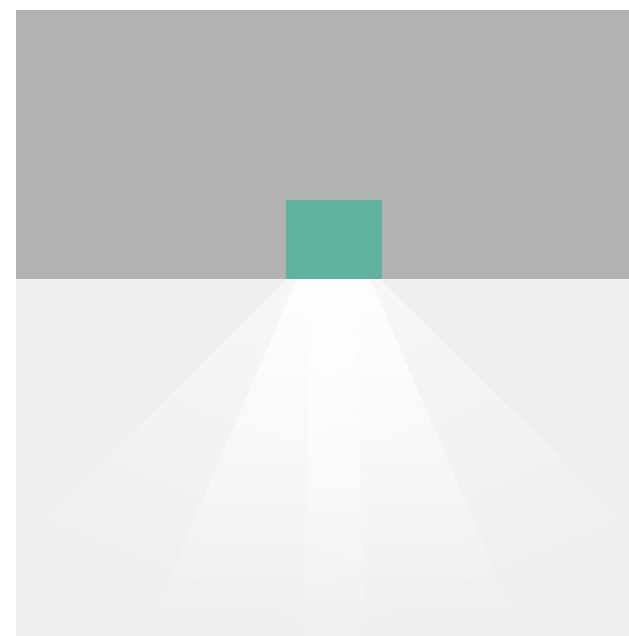
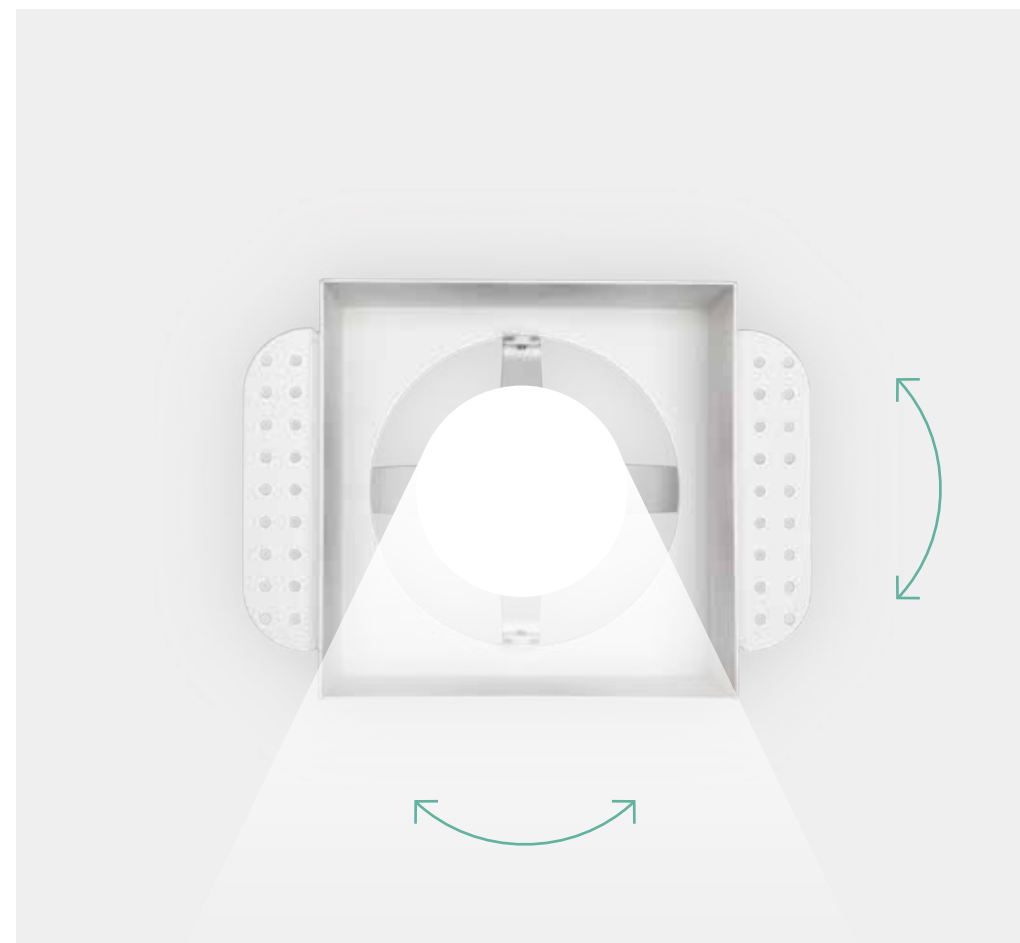
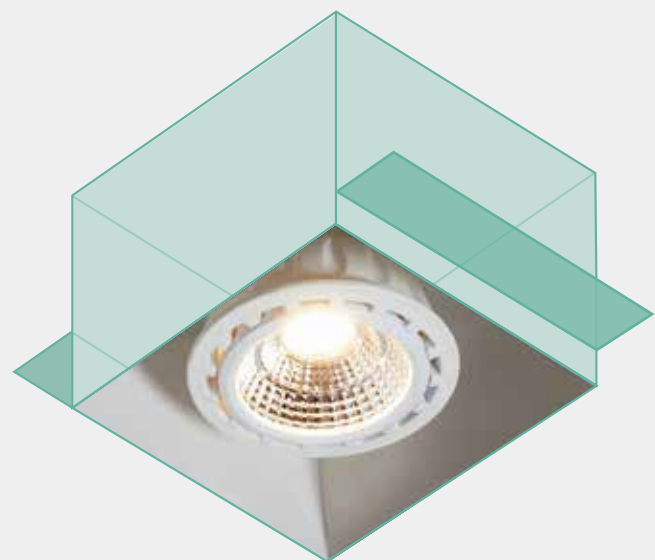

Wizard può essere orientato a seconda delle proprie necessità.
 Wizard can be adjusting accordint to one's needs.

INSTALLAZIONE MINIMALE

Wizard si distingue per la sua presenza discreta grazie al montaggio a raso che permette di fondere l'apparecchio con l'architettura della stanza.

MINIMAL FITTING

Wizard distinguishes itself for its discreet presence thanks to its trimless recessed mounting system which softly melts into the architecture of the room.

WIZARD



Lampadina esclusa / Bulb not included

CODE	FINISHING	BASE
42749	Bianco / White	GU10 230V 50/60Hz~ Max.50W
42750	Nero / Black	GU10 230V 50/60Hz~ Max.50W
42747	Bianco / White	AR111 GU10 230V 50/60Hz~ Max.50W
42748	Nero / Black	AR111 GU10 230V 50/60Hz~ Max.50W

INSTALLAZIONE APPLICATION

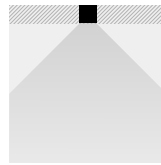

Incasso/Recessed

DISEGNI TECNICI TECHNICAL DRAWINGS

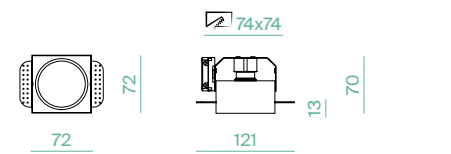

42749
42750

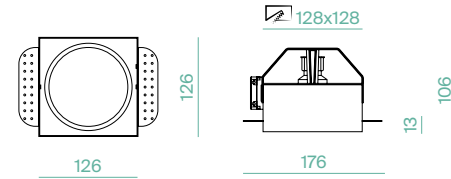

42747
42748

REGOLAZIONI ADJUSTABILITY



42749
42750



42747
42748

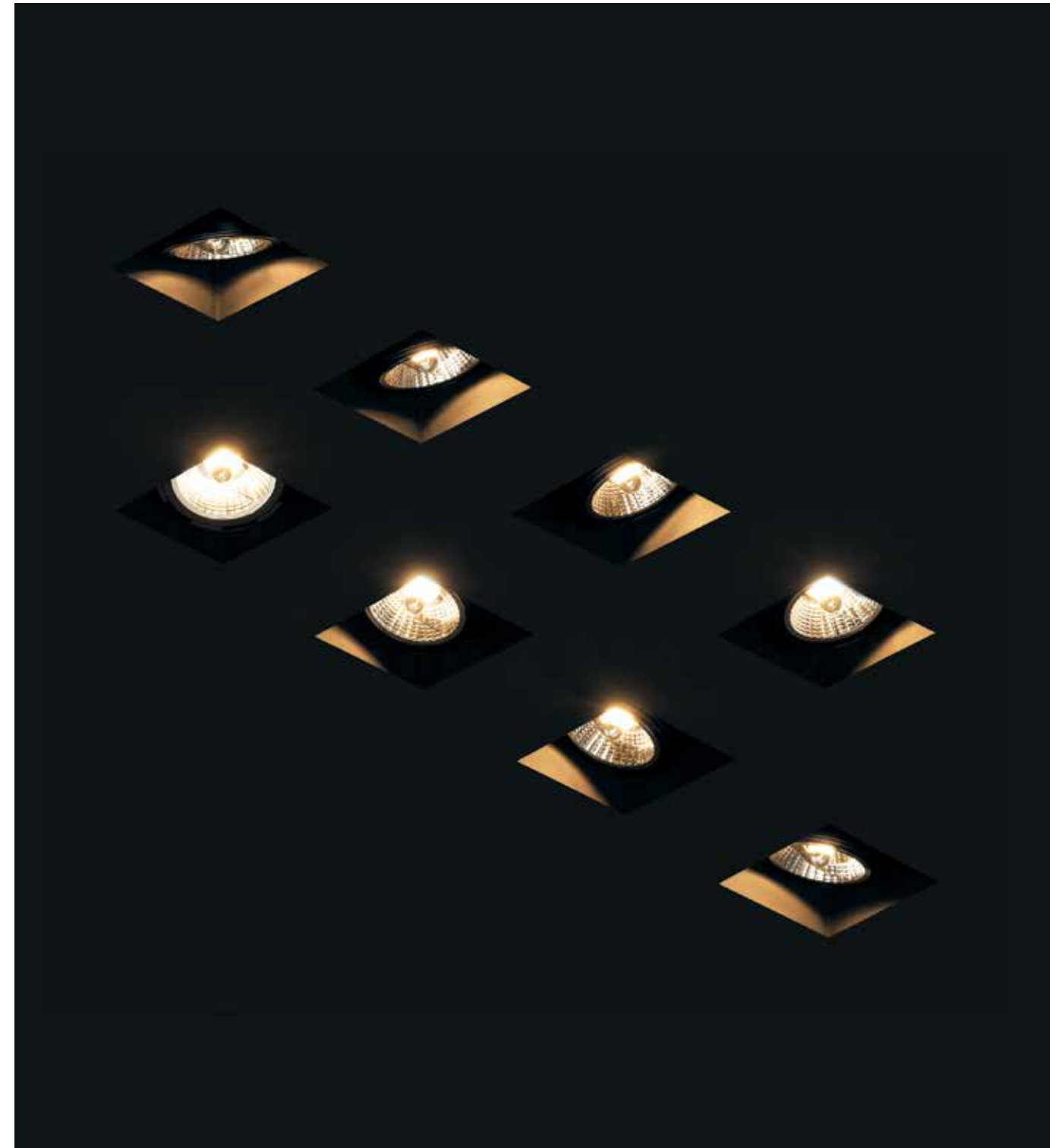

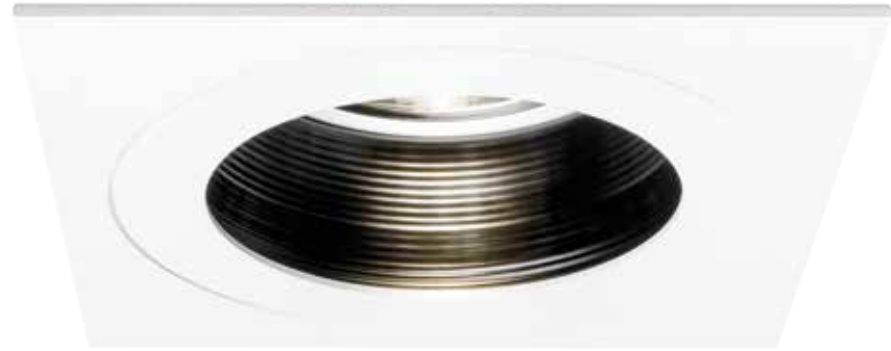

DEEP C/VETRO

Lampadina esclusa / Bulb not included

CODE	FINISHING	BASE
54511	Bianco / White	GU10 230V 50/60Hz
54541	Nero / Black	GU10 230V 50/60Hz

INSTALLAZIONE APPLICATION

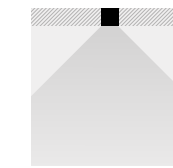

Incasso/Recessed

DISEGNI TECNICI TECHNICAL DRAWINGS

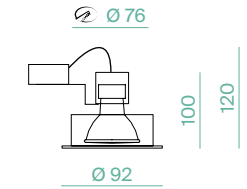

DEEP C/VETRO

Lampadina esclusa / Bulb not included

CODE	FINISHING	BASE
54527	Bianco / White	GU10 230V 50/60Hz
54542	Nero / Black	GU10 230V 50/60Hz

INSTALLAZIONE APPLICATION

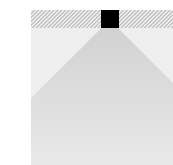

Incasso/Recessed

DISEGNI TECNICI TECHNICAL DRAWINGS

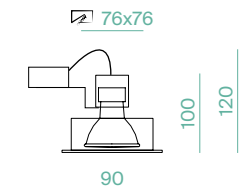

DEEP

Incasso per microiche
Corpo in pressofusione di alluminio verniciato
Diffusore in vetro satinato
Lampada non inclusa

Recessed fitting for MR-16
Painted die-cast aluminium body
Frosted glass screen
Bulb not included





DEEP ZERO

Lampadina esclusa / Bulb not included

CODE	FINISHING	BASE
54519	Bianco / White	GU10 230V 50/60Hz~ Max.50W
54543	Nero / Black	GU10 230V 50/60Hz~ Max.50W

INSTALLAZIONE APPLICATION

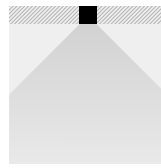

Incasso/Recessed

DISEGNI TECNICI TECHNICAL DRAWINGS

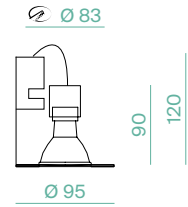

REGOLAZIONI ADJUSTABILITY



DEEP

Lampadina esclusa / Bulb not included

CODE	FINISHING	BASE
54523	Bianco / White	GU10 230V 50/60Hz~ Max.50W
54545	Nero / Black	GU10 230V 50/60Hz~ Max.50W

INSTALLAZIONE APPLICATION

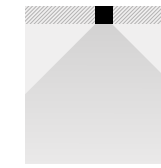

Incasso/Recessed

DISEGNI TECNICI TECHNICAL DRAWINGS

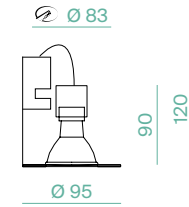

REGOLAZIONI ADJUSTABILITY



DEEP ZERO

Lampadina esclusa / Bulb not included

CODE	FINISHING	BASE
54531	Bianco / White	GU10 230V 50/60Hz~ Max.50W
54544	Nero / Black	GU10 230V 50/60Hz~ Max.50W

INSTALLAZIONE APPLICATION

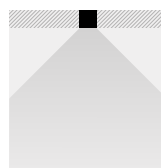

Incasso/Recessed

DISEGNI TECNICI TECHNICAL DRAWINGS

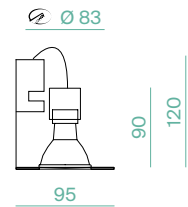

REGOLAZIONI ADJUSTABILITY



DEEP

Lampadina esclusa / Bulb not included

CODE	FINISHING	BASE
54539	Bianco / White	GU10 230V 50/60Hz
54546	Nero / Black	GU10 230V 50/60Hz

INSTALLAZIONE APPLICATION

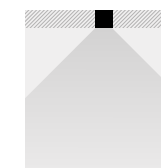

Incasso/Recessed

DISEGNI TECNICI TECHNICAL DRAWINGS

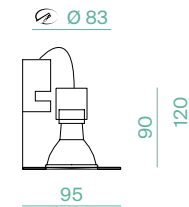

REGOLAZIONI ADJUSTABILITY





DEEP 111 ZERO

Lampadina esclusa / Bulb not included

CODE	FINISHING	BASE
58306	Bianco / White	AR111 GU10 230V 50/60Hz~ Max.50W
58353	Nero / Black	AR111 GU10 230V 50/60Hz~ Max.50W

INSTALLAZIONE APPLICATION

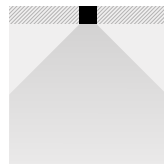

Incasso/Recessed

DISEGNI TECNICI TECHNICAL DRAWINGS

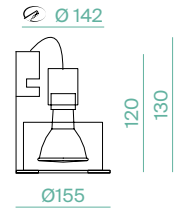

REGOLAZIONI ADJUSTABILITY



DEEP 111

Lampadina esclusa / Bulb not included

CODE	FINISHING	BASE
58338	Bianco / White	AR111 GU10 230V 50/60Hz~ Max.50W
58355	Nero / Black	AR111 GU10 230V 50/60Hz~ Max.50W

INSTALLAZIONE APPLICATION

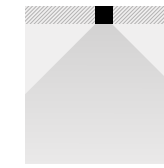

Incasso/Recessed

DISEGNI TECNICI TECHNICAL DRAWINGS

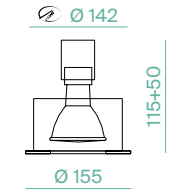

REGOLAZIONI ADJUSTABILITY



DEEP 111 ZERO

Lampadina esclusa / Bulb not included

CODE	FINISHING	BASE
58314	Bianco / White	AR111 GU10 230V 50/60Hz~ Max.50W
58354	Nero / Black	AR111 GU10 230V 50/60Hz~ Max.50W

INSTALLAZIONE APPLICATION

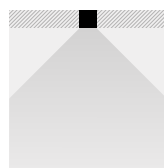

Incasso/Recessed

DISEGNI TECNICI TECHNICAL DRAWINGS

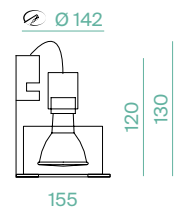

REGOLAZIONI ADJUSTABILITY



DEEP 111

Lampadina esclusa / Bulb not included

CODE	FINISHING	BASE
58346	Bianco / White	AR111 GU10 230V 50/60Hz
58356	Nero / Black	AR111 GU10 230V 50/60Hz

INSTALLAZIONE APPLICATION

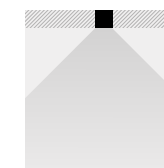

Incasso/Recessed

DISEGNI TECNICI TECHNICAL DRAWINGS

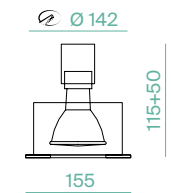

REGOLAZIONI ADJUSTABILITY



RECHARGEABLE

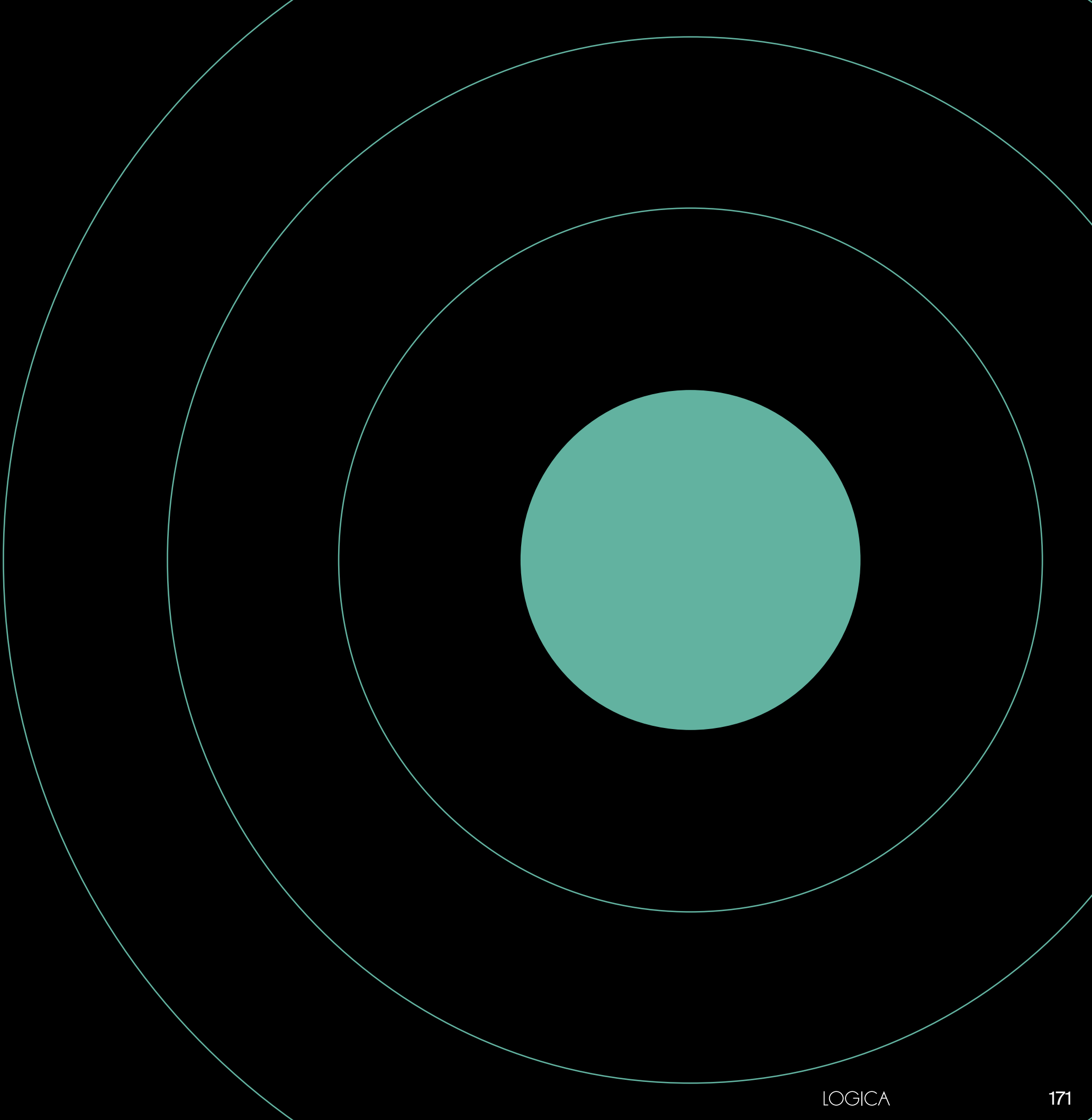



Diogene bianca/White Diogene

Diogene Hybrid



Twigg_Less

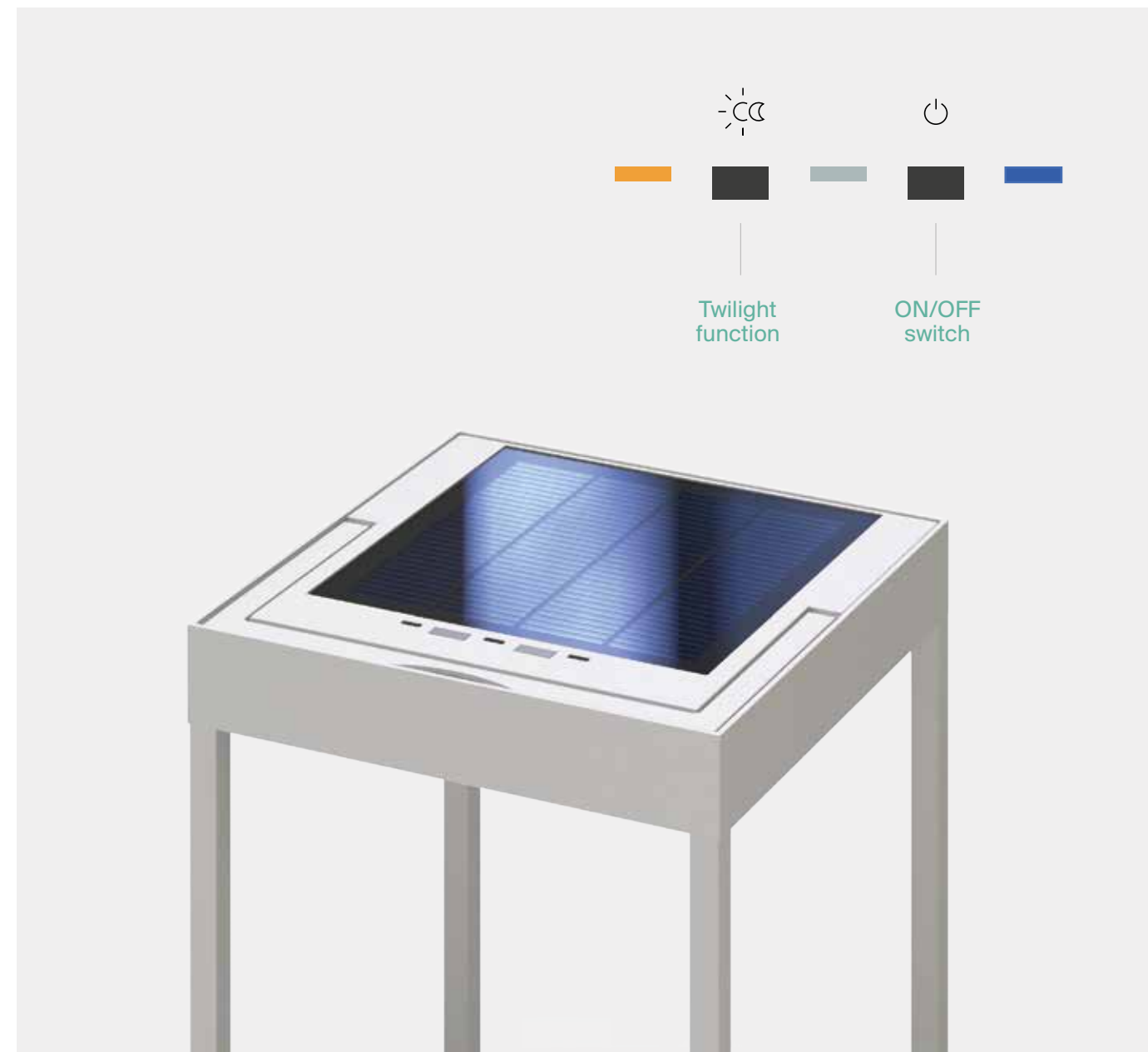
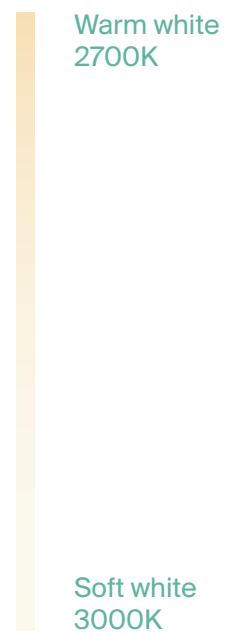

PERSONALIZZAZIONE LUCE

Attraverso il pannello di controllo è possibile selezionare la temperatura colore e il livello di intensità della luce a seconda delle proprie necessità di illuminazione.

TAILOR-MADE LIGHT

On the top panel control, colour temperature and light intensity can be adjusted according to the requested lighting requirements.

RICARICA SOLARE E PANNELLO DI CONTROLLO

Il pannello solare integrato ricarica Diogene Hybrid in 9 ore. L'interfaccia permette di scegliere tra l'accensione manuale e quella automatica (Twilight Function), la quale si attiva al crepuscolo grazie ad un sensore che rileva la luce ambientale.

SOLAR RECHARGE AND CONTROL PANEL

The integrated solar panel completely recharges Diogene Hybrid in 9 hours. To turn it on, you can choose between the manual or automatic mode (Twilight Function) which will get into action in the twilight thanks to a sensor which detects the light level in the surrounding area.

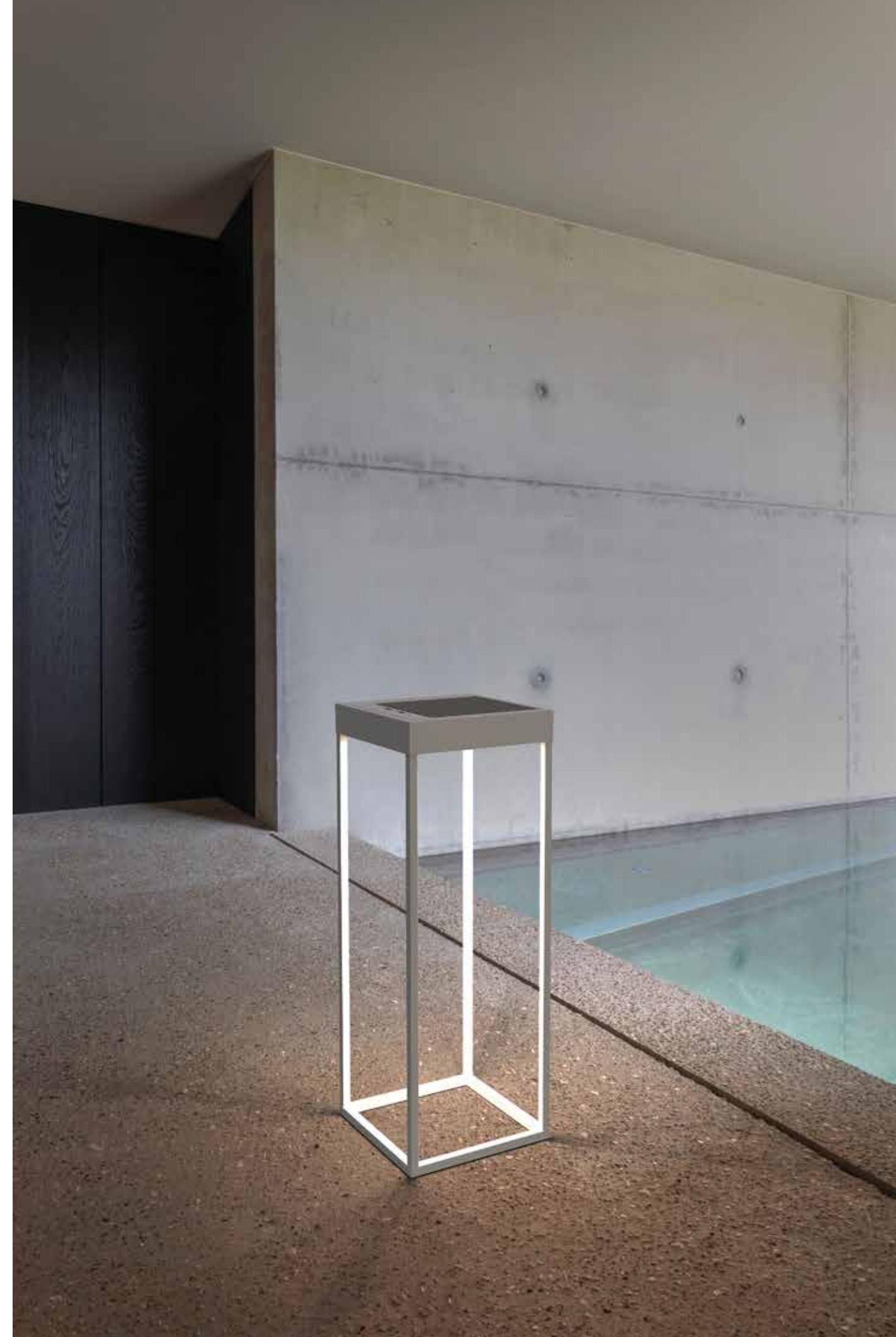

DIogene HYBRID

Lampada ricaricabile con doppio sistema di ricarica
(9h con pannello solare e 6h con cavo micro USB)
Regolazione T° colore (2700°K - 3000°K)
Illuminazione a LED dimmerabile
Autonomia 9h

Rechargeable lamp with double charging system.
(9h through solar panel and 6h by micro USB cable)
Selectable colour temperature (2700°K or 3000°K)
Dimmable LED light
9h autonomy



DIOGENE HYBRID

LED CRI SMD >80

Ricarica con pannello solare o cavo USB-C con alimentatore (compreso)
Charge through solar panel or USB-C cable with charger (included)

CODE	FINISHING	WATT	LUMEN	BEAM	KELVIN	VOLT
42764	Antracite/Anthracite	2.2W	150	120°	2700/3000K	DC 3.7V
42765	Bianco/White	2.2W	150	120°	2700/3000K	DC 3.7V
42766	Nero/Black	2.2W	150	120°	2700/3000K	DC 3.7V
42767	Corten	2.2W	150	120°	2700/3000K	DC 3.7V
42768	Sabbia/Sand	2.2W	150	120°	2700/3000K	DC 3.7V

INSTALLAZIONE APPLICATION

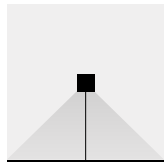

Appoggio/Standing

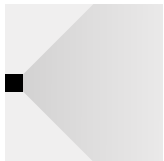

Parete/Wall

DISEGNI TECNICI TECHNICAL DRAWINGS

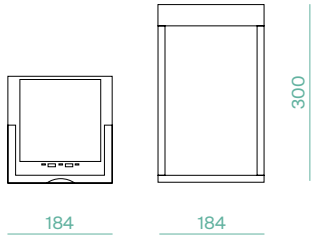

5 GARANZIA WARRANTY IP65 IK06 CE



DIOGENE HYBRID L

LED CRI SMD >80

Ricarica con pannello solare o cavo USB-C con alimentatore (compreso)
Charge through solar panel or USB-C cable with charger (included)

CODE	FINISHING	WATT	LUMEN	BEAM	KELVIN	VOLT
42769	Antracite/Anthracite	2.2W	150	120°	2700/3000K	DC 3.7V
42770	Bianco/White	2.2W	150	120°	2700/3000K	DC 3.7V
42771	Nero/Black	2.2W	150	120°	2700/3000K	DC 3.7V
42772	Corten	2.2W	150	120°	2700/3000K	DC 3.7V
42773	Sabbia/Sand	2.2W	150	120°	2700/3000K	DC 3.7V

INSTALLAZIONE APPLICATION

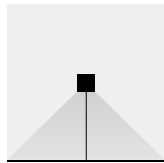

Appoggio/Standing



Parete/Wall

DISEGNI TECNICI TECHNICAL DRAWINGS

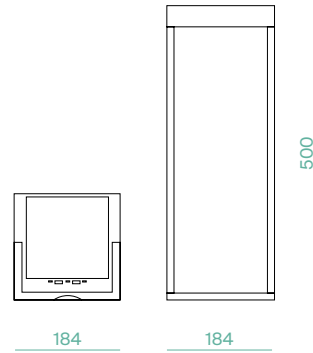

5 GARANZIA WARRANTY IP65 IK06 CE

ACCESSORI ACCESSORIES

CODE	COLOR	DESCRIPTION
11659	Antracite/Anthracite	Staffa per montaggio a muro/Wall mounting brackets
11660	Bianco/White	Staffa per montaggio a muro/Wall mounting brackets
11661	Nero/Black	Staffa per montaggio a muro/Wall mounting brackets
11662	Corten	Staffa per montaggio a muro/Wall mounting brackets
11663	Sabbia/Sand	Staffa per montaggio a muro/Wall mounting brackets

DISEGNI TECNICI TECHNICAL DRAWINGS

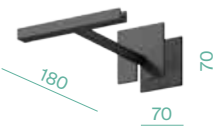



DIogene

Lampada ricaricabile con cavo micro USB
Illuminazione a LED dimmerabile
Autonomia 9h

Rechargeable lamp by micro USB cable.
Dimmable LED light
9h autonomy



DIOGENE

LED
CRI
SMD
>80

Ricarica con cavo Micro USB con alimentatore (compreso)
Charge through Micro USB cable with charger (included)

CODE	FINISHING	WATT	LUMEN	BEAM	KELVIN	VOLT
42720	Antracite/ Anthracite	2.2W	200	120°	2700K/3000K	DC 3.7V
42721	Bianco/White	2.2W	200	120°	2700K/3000K	DC 3.7V
42722	Nero/Black	2.2W	200	120°	2700K/3000K	DC 3.7V
42723	Corten	2.2W	200	120°	2700K/3000K	DC 3.7V
42762	Sabbia/Sand	2.2W	200	120°	2700K/3000K	DC 3.7V

INSTALLAZIONE APPLICATION

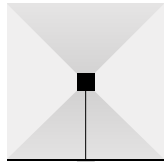

Appoggio/Standing

DISEGNI TECNICI TECHNICAL DRAWINGS

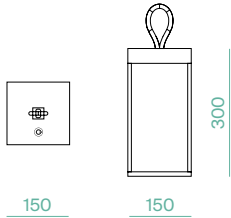

DIOGENE L

LED
CRI
SMD
>80

Ricarica con cavo Micro USB con alimentatore (compreso)
Charge through Micro USB cable with charger (included)

CODE	FINISHING	WATT	LUMEN	BEAM	KELVIN	VOLT
42724	Antracite/ Anthracite	2.2W	200	120°	2700K/3000K	DC 3.7V
42725	Bianco/White	2.2W	200	120°	2700K/3000K	DC 3.7V
42726	Nero/Black	2.2W	200	120°	2700K/3000K	DC 3.7V
42727	Corten	2.2W	200	120°	2700K/3000K	DC 3.7V
42763	Sabbia/Sand	2.2W	200	120°	2700K/3000K	DC 3.7V

INSTALLAZIONE APPLICATION

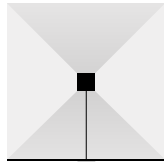

Appoggio/Standing

DISEGNI TECNICI TECHNICAL DRAWINGS

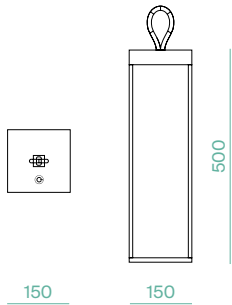

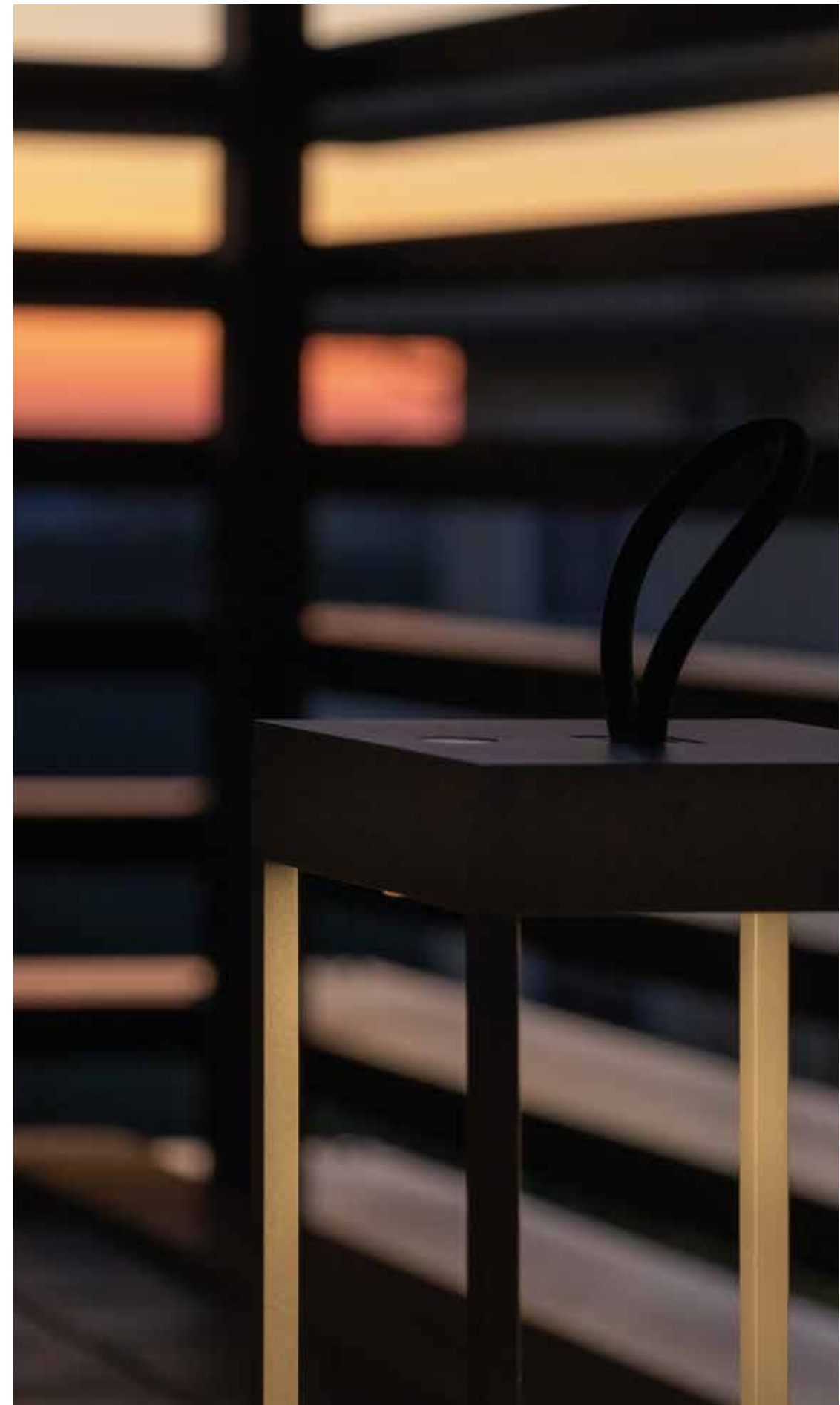

Diogene bianca/White Diogene

Diogene L Antracite/Anthracite Diogene L

2700K

3000K

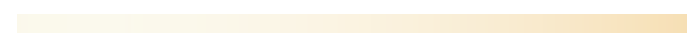

Warm white
2700K

Soft white
3000K

REGOLAZIONE T° COLORE

Twigg_Less offre la possibilità di selezionare la temperatura colore adeguata alle circostanze.

COLOUR TEMPERATURE SETTING

Twigg_Less allows colour temperature selection depending on the customer's request.



LOGICA



TWIGGY_LESS

Lampada ricaricabile con sistema di ricarica wireless
Regolazione T° colore (2700°K - 3000°K)
Illuminazione a LED dimmerabile
Autonomia 9h

Rechargeable lamp through wireless base.
Selectable colour temperature (2700°K or 3000°K)
Dimmable LED light
9h autonomy



TWIGGY_LESS

LED CRI SMD >80

Ricarica con base di appoggio wireless con alimentatore (compreso)
Charge through wireless base with charger (included)

CODE	FINISHING	WATT	LUMEN	BEAM	KELVIN	VOLT
42753	Antracite/Anthracite	2.2W	150	100°	2700/3000K	DC 3.7V
42754	Bianco/White	2.2W	150	100°	2700/3000K	DC 3.7V
42755	Nero/Black	2.2W	150	100°	2700/3000K	DC 3.7V
42756	Corten	2.2W	150	100°	2700/3000K	DC 3.7V
42757	Giallo/Yellow	2.2W	150	100°	2700/3000K	DC 3.7V
42758	Arancione/Orange	2.2W	150	100°	2700/3000K	DC 3.7V
42759	Verde Salvia/Sage Green	2.2W	150	100°	2700/3000K	DC 3.7V
42760	Blu Avio	2.2W	150	100°	2700/3000K	DC 3.7V
42761	Sabbia/Sand	2.2W	150	100°	2700/3000K	DC 3.7V

INSTALLAZIONE APPLICATION

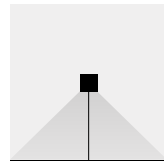

Appoggio/Standing

DISEGNI TECNICI TECHNICAL DRAWINGS

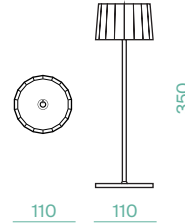

5 GARANZIA WARRANTY IP65 IK06 CE



Twigg_Less Blu Avio

ACCESSORI ACCESSORIES

CODE	DESCRIPTION	ALIMENTAZIONE/AC-DC ADAPTOR
11654	Base ricarica multipla x6 lampade Multiple charger x6 lamps	100-240V 50/60Hz 9VDC 5A 45W

DISEGNI TECNICI TECHNICAL DRAWINGS

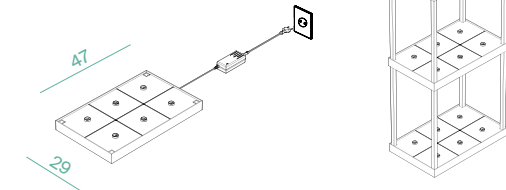

CEILING LIGHTS

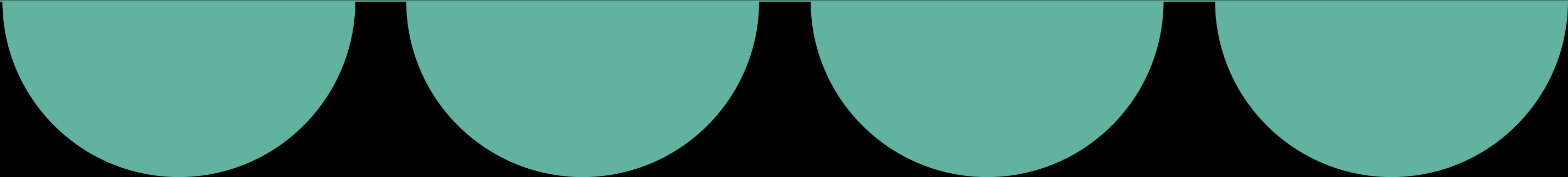



ALTAIR

Proiettore LED orientabile a 360°
Corpo in alluminio pressofuso verniciato
Riflettore brillantato

LED adjustable spotlight
Painted die-cast aluminium body
Multi-faceted reflector

DESIGN

Altair permette di ottenere la massima versatilità di utilizzo grazie al suo design minimale che lo rende collocabile in ogni ambiente, applicandolo a soffitto oppure a parete.

DESIGN

Altair allows multiple solutions in terms of application. Thanks to its essential design, it can be installed in any environment either as ceiling fitting or as wall bracket.

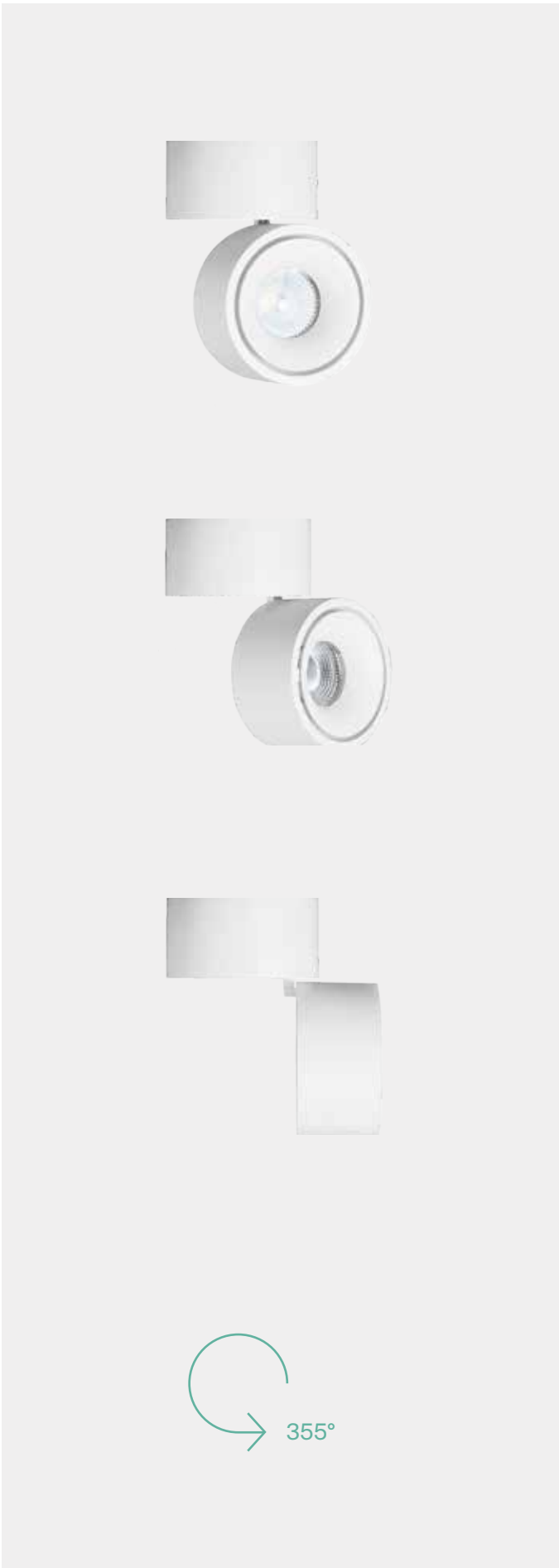



ALTAIR 9.8W

LED
CRI
PF

EPISTAR
>90
0.9

CODE	FINISHING	WATT	LUMEN	BEAM	KELVIN
42735	Bianco/White	9.8W	733	36°	3000K
42736	Nero/Black	9.8W	733	36°	3000K

INSTALLAZIONE APPLICATION

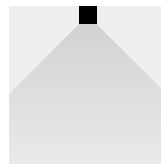

Soffitto/Ceiling

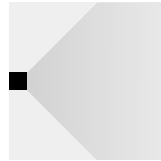

Parete/Wall

DISEGNI TECNICI TECHNICAL DRAWINGS

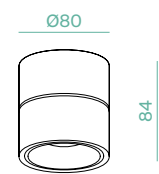

REGOLAZIONI ADJUSTABILITY

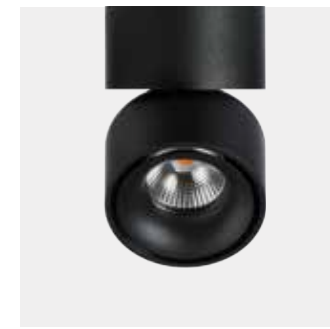

ALTAIR 14W

LED
CRI
PF

EPISTAR
>90
0.9

CODE	FINISHING	WATT	LUMEN	BEAM	KELVIN
42751	Bianco/White	14W	1050	36°	3000K
42752	Nero/Black	14W	1050	36°	3000K

INSTALLAZIONE APPLICATION

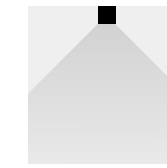

Soffitto/Ceiling

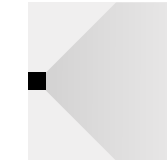

Parete/Wall

DISEGNI TECNICI TECHNICAL DRAWINGS

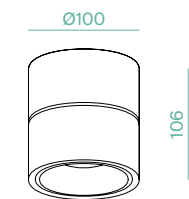

REGOLAZIONI ADJUSTABILITY

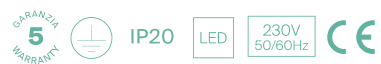



CYL

Apparecchio a soffitto LED integrato
Corpo in pressofusione di alluminio verniciato
Driver incluso

Ceiling fitting with built-in LED
Painted die-cast aluminium body
Driver included



CYL

LED Bridgelux
CRI >90
PF 0.5

CODE	FINISHING	WATT	LUMEN	BEAM	KELVIN
41705	Nero/Black	12W	890	55°	3000K
41706	Bianco/White	12W	890	55°	3000K

INSTALLAZIONE APPLICATION

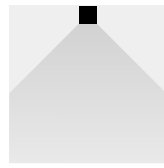

Soffitto/Ceiling

DISEGNI TECNICI TECHNICAL DRAWINGS

Ø80



Cyl bianco/White Cyl





CONTAINER

Apparecchio a soffitto per microiche e AR111
Corpo in acciaio verniciato
Lampadina non inclusa

Ceiling fitting for MR-16 and AR111
Painted steel body
Bulbs not included



CONTAINER

Lampadina esclusa / Bulb not included

CODE	FINISHING	BASE
56900/230	Interno nero / Inside black	GU10 230V 50/60Hz~ Max.50W
57900/230	Interno bianco / inside white	GU10 230V 50/60Hz~ Max.50W

INSTALLAZIONE APPLICATION

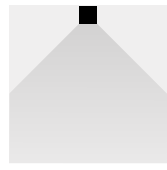

Soffitto/Ceiling

DISEGNI TECNICI TECHNICAL DRAWINGS

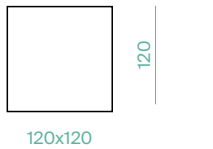

120x120

REGOLAZIONI ADJUSTABILITY



±45°



CONTAINER

Lampadina esclusa / Bulb not included

CODE	FINISHING	BASE
56901/230	Interno nero / Inside black	GU10 230V 50/60Hz~ Max.2x50W
57901/230	Interno bianco / Inside white	GU10 230V 50/60Hz~ Max.2x50W

INSTALLAZIONE APPLICATION

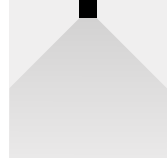

Soffitto/Ceiling

DISEGNI TECNICI TECHNICAL DRAWINGS



225x120

REGOLAZIONI ADJUSTABILITY



±45°

LED IP20 230V 50/60Hz CE



CONTAINER

Lampadina esclusa / Bulb not included

CODE	FINISHING	BASE
56902/230	Interno nero / Inside black	GU10 230V 50/60Hz~ Max.3x50W
57902/230	Interno bianco / inside white	GU10 230V 50/60Hz~ Max.3x50W

INSTALLAZIONE APPLICATION

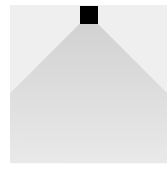

Soffitto/Ceiling

DISEGNI TECNICI TECHNICAL DRAWINGS

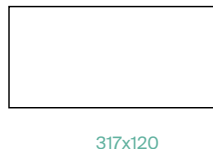

317x120

REGOLAZIONI ADJUSTABILITY



±45°

LED IP20 230V 50/60Hz CE



CONTAINER 111

Lampadina esclusa / Bulb not included

CODE	FINISHING	BASE
53903/230	Interno nero / Inside black	AR111 GU10 230V 50/60Hz~ Max.50W
57903/230	Interno bianco / inside white	AR111 GU10 230V 50/60Hz~ Max.50W

INSTALLAZIONE APPLICATION

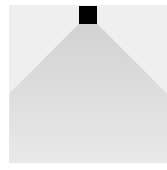

Soffitto/Ceiling

DISEGNI TECNICI TECHNICAL DRAWINGS



180x180

REGOLAZIONI ADJUSTABILITY



±45°



CONTAINER 111

Lampadina esclusa / Bulb not included

CODE	FINISHING	BASE
56905/230	Interno nero / Inside black	AR111 GU10 230V 50/60Hz~ 3xMax.50W
57905/230	Interno bianco / inside white	AR111 GU10 230V 50/60Hz~ 3xMax.50W

INSTALLAZIONE APPLICATION

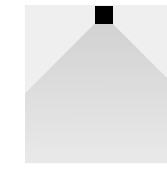

Soffitto/Ceiling

DISEGNI TECNICI TECHNICAL DRAWINGS

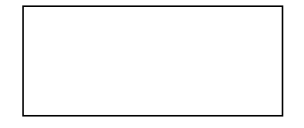

500x180

REGOLAZIONI ADJUSTABILITY



±45°



CONTAINER 111

Lampadina esclusa / Bulb not included

CODE	FINISHING	BASE
56904/230	Interno nero / Inside black	AR111 GU10 230V 50/60Hz~ Max.2x50W
57904/230	Interno bianco / inside white	AR111 GU10 230V 50/60Hz~ Max.2x50W

INSTALLAZIONE APPLICATION

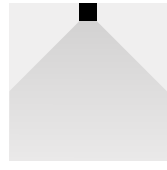

Soffitto/Ceiling

DISEGNI TECNICI TECHNICAL DRAWINGS

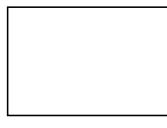

348x180

REGOLAZIONI ADJUSTABILITY



±45°





BOX

Apparecchio a soffitto per microiche e AR111
Corpo in alluminio verniciato
Lampadina non inclusa

Ceiling fitting for MR-16 and AR111
Aluminium steel body
Bulbs not included



BOX DICRO

Lampadina esclusa / Bulb not included

CODE	FINISHING	BASE
43166	Nero / Black	GU10 100-240V ~ Max.50W
43167	Bianco / White	GU10 100-240V ~ Max.50W

INSTALLAZIONE APPLICATION

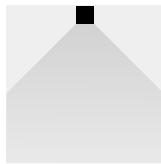

Soffitto/Ceiling

DISEGNI TECNICI TECHNICAL DRAWINGS

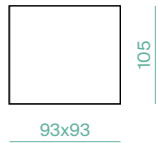

REGOLAZIONI ADJUSTABILITY



BOX 111

Lampadina esclusa / Bulb not included

CODE	FINISHING	BASE
43164	Nero / Black	AR111 GU10 100-240V ~ Max.20W
43165	Bianco / White	AR111 GU10 100-240V ~ Max.20W

INSTALLAZIONE APPLICATION

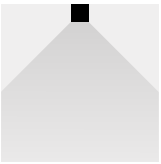

Soffitto/Ceiling

DISEGNI TECNICI TECHNICAL DRAWINGS



REGOLAZIONI ADJUSTABILITY





UNICO DICRO SOFFITTO/PARETE

Lampadina esclusa / Bulb not included

CODE	FINISHING	BASE
40760	Bianco/White	GU10 230V 50/60HZ
40761	Nero/Black	GU10 230V 50/60HZ

INSTALLAZIONE APPLICATION

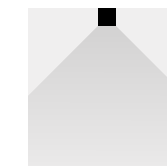

Soffitto/Ceiling

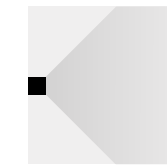

Parete/Wall

DISEGNI TECNICI TECHNICAL DRAWINGS

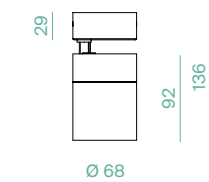

REGOLAZIONI ADJUSTABILITY



UNICO DICRO

Proiettore orientabile per lampade LED DICRO
Corpo in alluminio verniciato
Montaggio a soffitto
Lampadina non inclusa

Adjustable tracklight for LED DICRO bulbs
Painted aluminium body
Ceiling mounting
Bulb not included





ORBIT SOFFITTO/PARETE

Lampadina esclusa / Bulb not included

CODE	FINISHING	BASE
53842	Bianco/White	AR111 GU10 230V 50/60HZ
53843	Nero/Black	AR111 GU10 230V 50/60HZ

INSTALLAZIONE APPLICATION

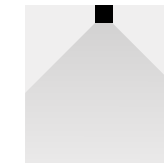

Soffitto/Ceiling

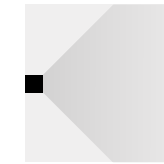

Parete/Wall

DISEGNI TECNICI TECHNICAL DRAWINGS

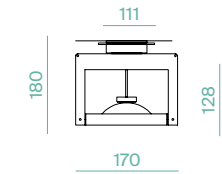

REGOLAZIONI ADJUSTABILITY



ORBIT

Proiettore per lampade LED AR111 orientabile
Corpo in alluminio verniciato
Montaggio a soffitto, parete
Lampadina non inclusa

Adjustable tracklight for LED AR111 bulbs
Painted aluminium body
Ceiling or wall mounting
Bulbs not included



SUSPENSION LIGHTS

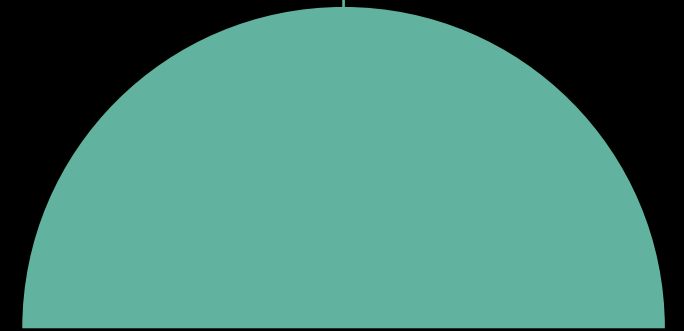
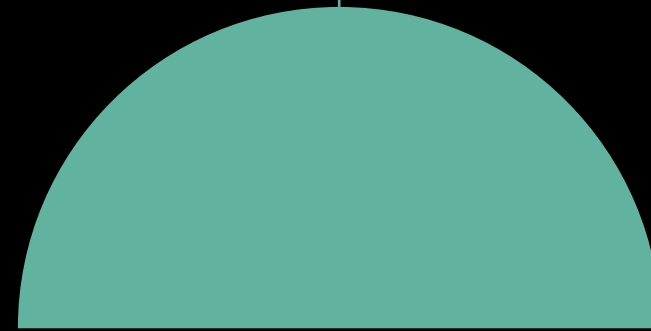
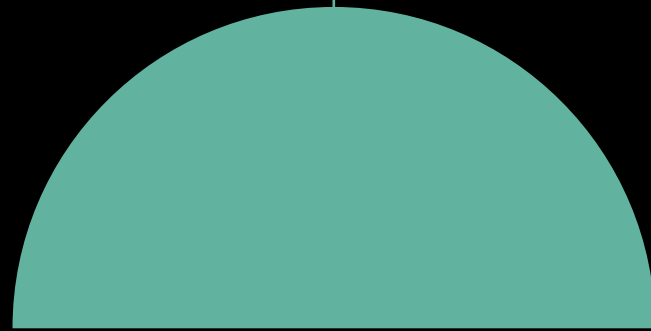
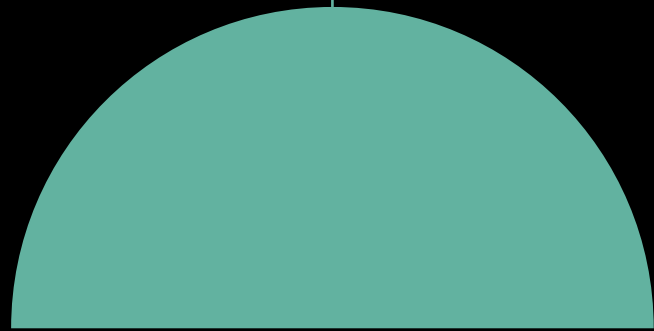



CYL SOSP

Apparecchio a sospensione LED integrato
Corpo in pressofusione di alluminio verniciato
Driver incluso

Suspension fitting with built-in LED
Painted die-cast aluminium body
Driver included

CYL
SOSP

LED Bridgelux
CRI >90
PF 0.5

CODE	FINISHING	WATT	LUMEN	BEAM	KELVIN
41707	Nero/Black	12W	890	55°	3000K
41708	Bianco/White	12W	890	55°	3000K

INSTALLAZIONE
APPLICATION

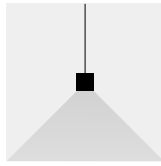

Sospensione/
Suspension

DISEGNI TECNICI
TECHNICAL DRAWINGS

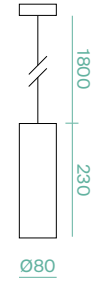



SHANGHAI

Apparecchio a sospensione LED integrato
Corpo in pressofusione di alluminio verniciato
Driver incluso

Suspension fitting with built-in LED
Painted die-cast aluminium body
Driver included

SHANGHAI_30

LED
CRI 90
PF 0.5

Bridgelux
90
0.5

CODE	FINISHING	WATT	LUMEN	BEAM	KELVIN
43160	Nero/Black	7.5W	490	15°	3000K
43161	Bianco/White	7.5W	490	15°	3000K

INSTALLAZIONE APPLICATION

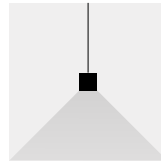

Sospensione/
Suspension

DISEGNI TECNICI TECHNICAL DRAWINGS

Ø60

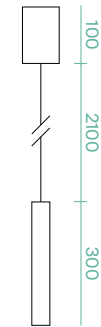

Ø30



SHANGHAI_50

LED
CRI 90
PF 0.5

Bridgelux
90
0.5

CODE	FINISHING	WATT	LUMEN	BEAM	KELVIN
43162	Nero/Black	7.5W	490	15°	3000K
43163	Bianco/White	7.5W	490	15°	3000K

INSTALLAZIONE APPLICATION

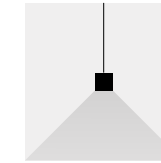

Sospensione/
Suspension

DISEGNI TECNICI TECHNICAL DRAWINGS

Ø60

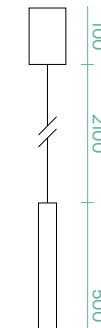

Ø30



WALL LIGHTS

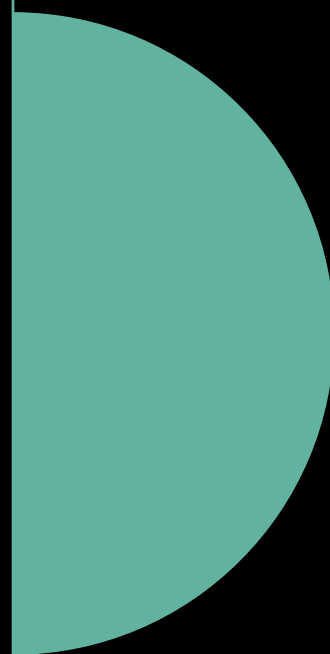
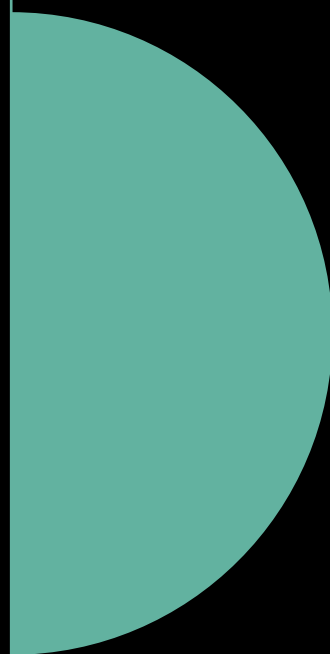
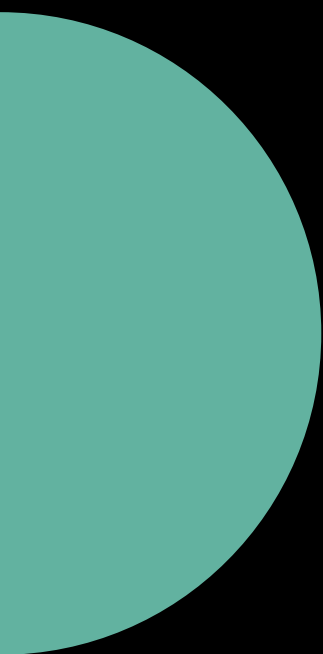

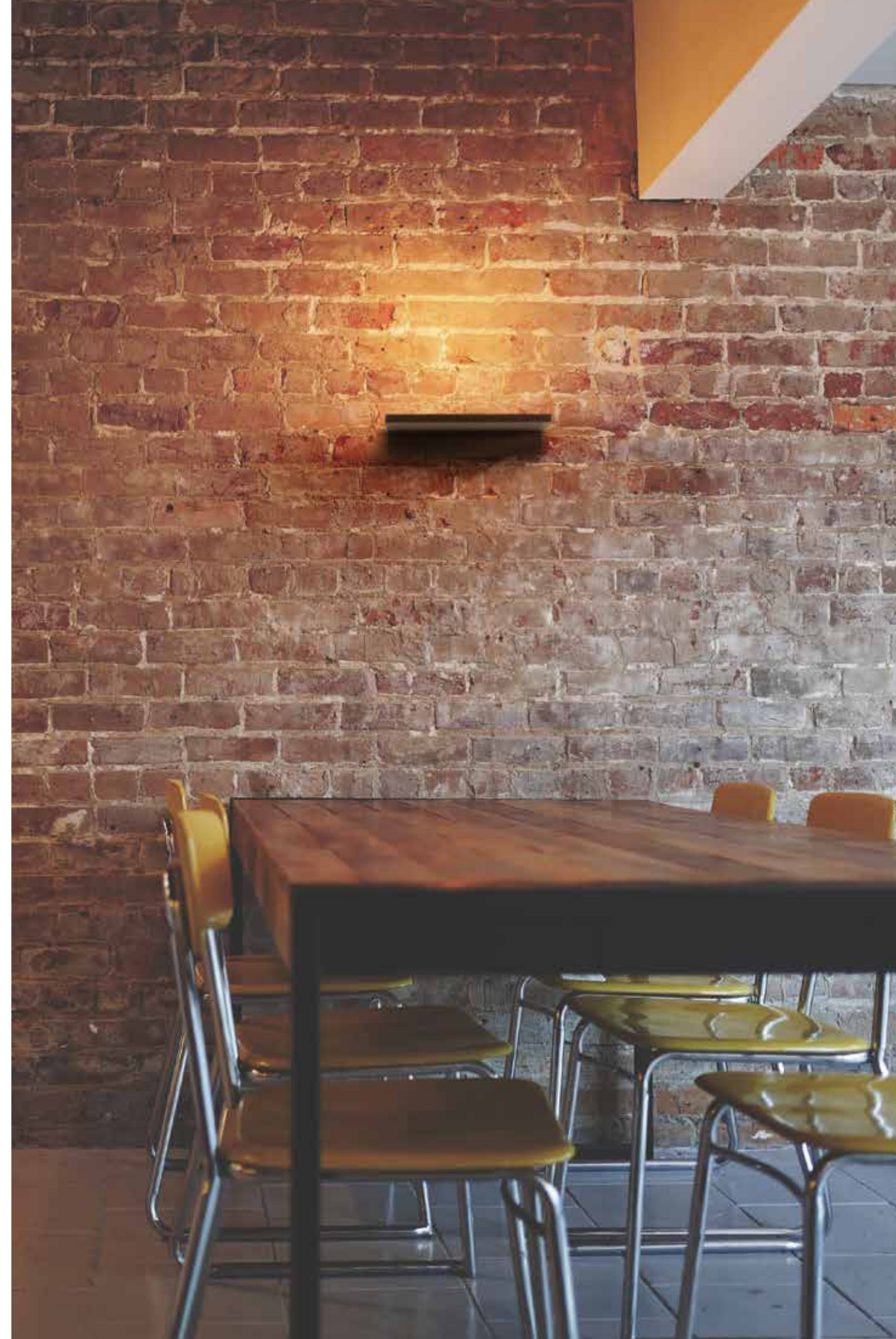

MINIMA

Apparecchio con montaggio a parete
Corpo in alluminio lavorato dal pieno
Led integrato con dimmerazione a taglio di fase

Wall fitting
Aluminium body obtained from an aluminium block
Phase-cut dimming integrated LED



Minima bianca/White Minima



Minima nera/Black Minima



Minima nera/Black Minima

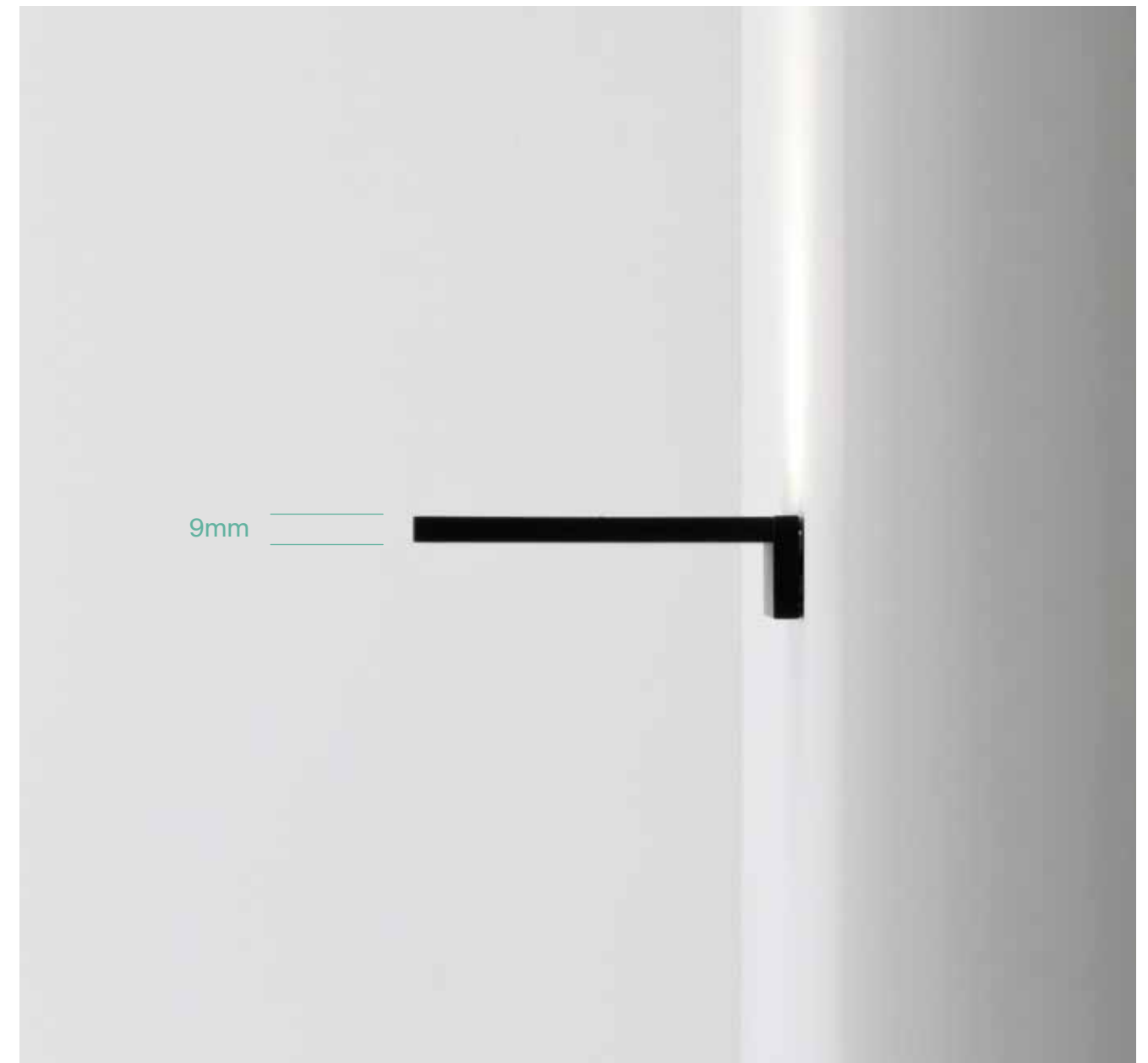
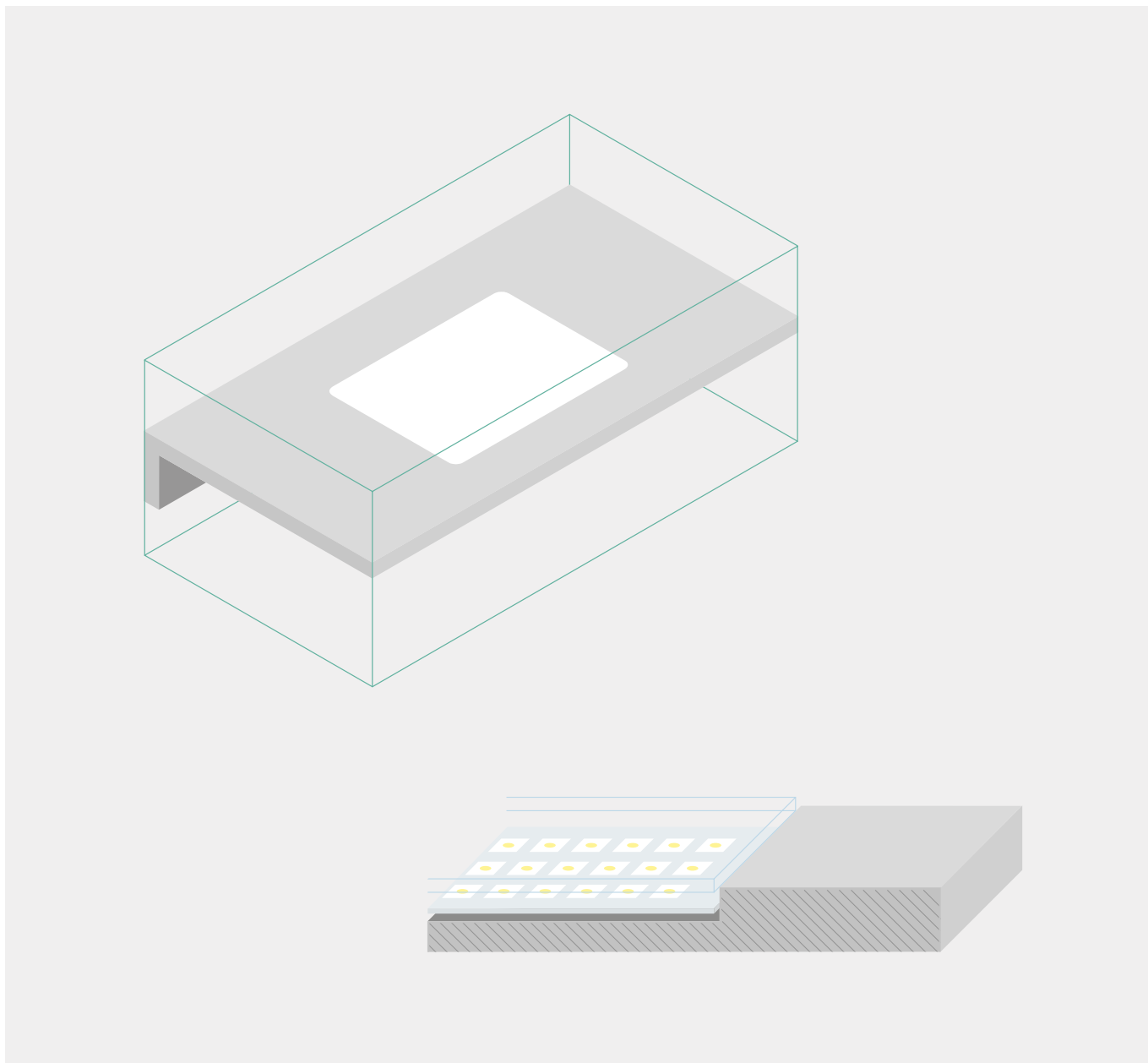

9mm

LAVORAZIONE

Il corpo prende forma da un'accurata lavorazione dell'alluminio dal pieno con tecnologia CNC; questo specifico processo produttivo permette di fornire un supporto dissipante ottimale. Il corpo ingloba all'interno una piastra LED dimmerabile a taglio di fase che, con l'aggiunta dell'interfaccia, può essere gestito con il sistema DALI.

MANUFACTURING PROCESS

The body stems from an accurate CNC process of the aluminium block. This specific working process guarantees an excellent heat sink. The body incorporates a phase dimming LED board which can be eventually connected to an interface which would also allow DALI control.

SPESSORE

Grazie al suo spessore minimale, Minima è un oggetto adatto ad essere inserito in qualsiasi ambiente, dal più complesso al più semplice.

THICKNESS

Thanks to its thin thickness, Minima is an object suitable to be installed in any environment, be it articulate or simple and essential interior designing.



MINIMA

LED Seoul SC
 CRI 90
 PF 0.9

CODE	FINISHING	WATT	LUMEN	BEAM	KELVIN	MODE
42706	Bianco/White	20W	1900	120°	3000K	Dimm. taglio di fase/ Phase cut dimming
42707	Nero/Black	20W	1900	120°	3000K	Dimm. taglio di fase/ Phase cut dimming

INSTALLAZIONE APPLICATION

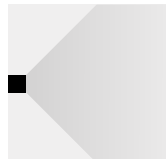

Parete/Wall

DISEGNI TECNICI TECHNICAL DRAWINGS

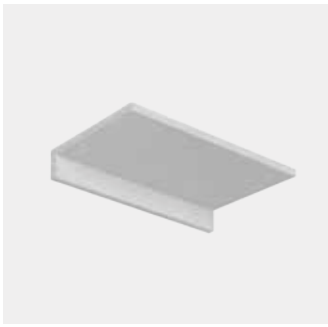
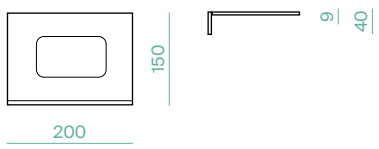

MINIMA L

LED Seoul SC
 CRI 90
 PF 0.9

CODE	FINISHING	WATT	LUMEN	BEAM	KELVIN	MODE
42708	Bianco/White	30W	2900	120°	3000K	Dimm. taglio di fase/ Phase cut dimming
42709	Nero/Black	30W	2900	120°	3000K	Dimm. taglio di fase/ Phase cut dimming

INSTALLAZIONE APPLICATION

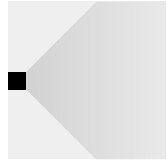

Parete/Wall

DISEGNI TECNICI TECHNICAL DRAWINGS

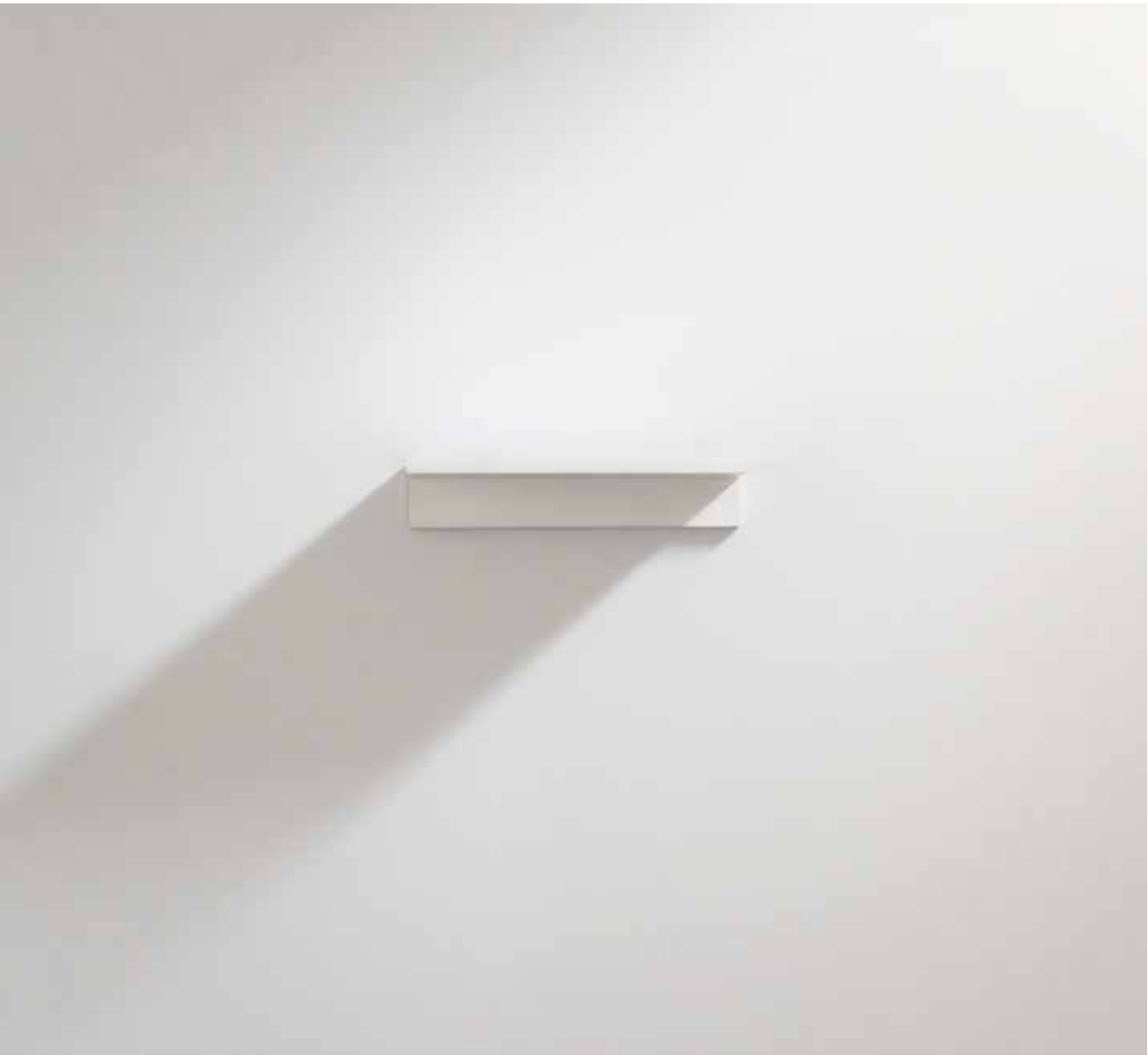
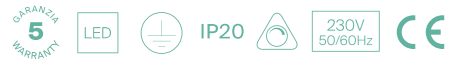
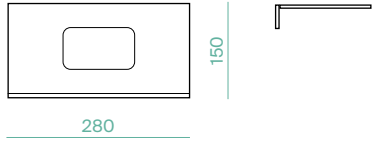

Minima bianca/White Minima

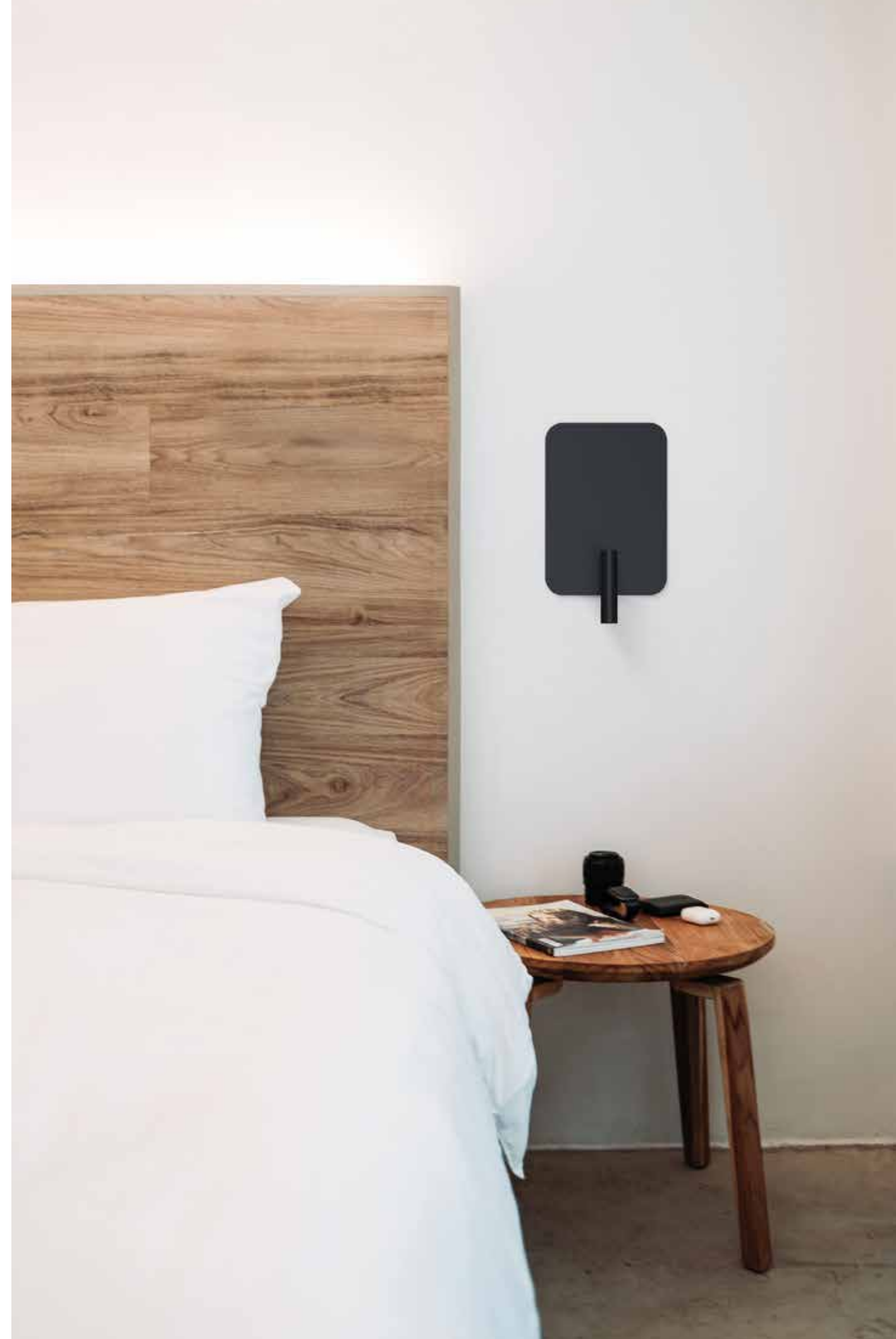

AURORA

Luce testata letto led integrato doppia emissione
Braccio regolabile e doppio interruttore indipendente
Corpo in acciaio cromato o verniciato

Double emission built-in LED wall-light
Adjustable arm and two independent switches
Chrome or painted steel body



AURORA TONDA

LED Sanan+Seoul
CRI >80
PF >0.5

CODE	FINISHING	WATT	LUMEN	KELVIN	DRIVER
42623	Bianco/White	5W+3W	480+150	3000K	450mA 12V + 700mA 6V
42624	Nero/Black	5W+3W	480+150	3000K	450mA 12V + 700mA 6V
42625	Cromo / Chrome	5W+3W	480+150	3000K	450mA 12V + 700mA 6V

INSTALLAZIONE APPLICATION

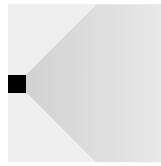

Parete/Wall

DISEGNI TECNICI TECHNICAL DRAWINGS

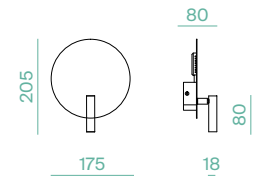

REGOLAZIONI ADJUSTABILITY



AURORA QUADRA

LED Sanan+Seoul
CRI >80
PF >0.5

CODE	FINISHING	WATT	LUMEN	KELVIN	DRIVER
42626	Bianco/White	5W+3W	480+150	3000K	450mA 12V + 700mA 6V
42627	Nero/Black	5W+3W	480+150	3000K	450mA 12V + 700mA 6V
42628	Cromo / Chrome	5W+3W	480+150	3000K	450mA 12V + 700mA 6V

INSTALLAZIONE APPLICATION

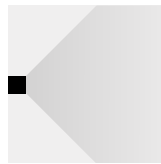

Parete/Wall

DISEGNI TECNICI TECHNICAL DRAWINGS

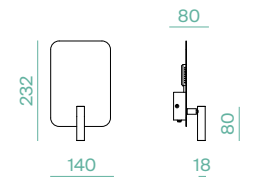

REGOLAZIONI ADJUSTABILITY



Aurora Tonda nera/Black Aurora Tonda

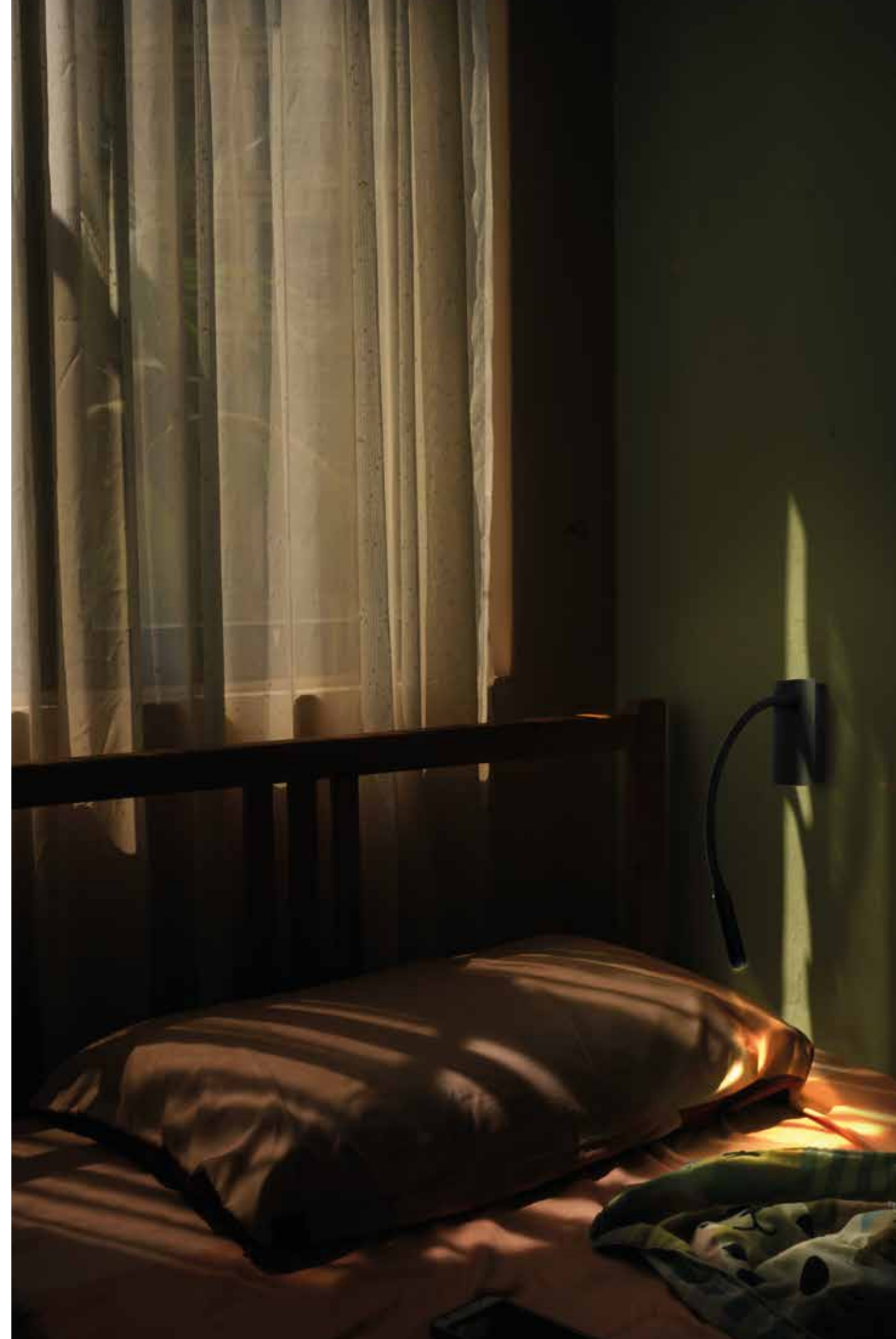

DUMBO

Luce testata letto led integrato con braccio flessibile
Interuttore indipendente

Corpo in acciaio cromato o verniciato nero

Flexible built-in LED wall-light
Independent switch

Chrome or black painted steel body



DUMBO FLEX

LED Seoul
CRI >80
PF >0.5

CODE	FINISHING	WATT	LUMEN	KELVIN	DRIVER
42619	Nero / Black	3W	150	3000K	700mA 6V
42620	Cromo / Chrome	3W	150	3000K	700mA 6V

INSTALLAZIONE APPLICATION

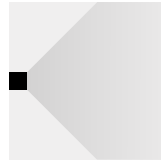

Parete/Wall

DISEGNI TECNICI TECHNICAL DRAWINGS

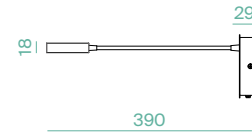

REGOLAZIONI ADJUSTABILITY



DUMBO

LED Seoul
CRI >80
PF >0,5

CODE	FINISHING	WATT	LUMEN	KELVIN	DRIVER
42621	Nero / Black	3W	150	3000K	700mA 6V
42622	Cromo / Chrome	3W	150	3000K	700mA 6V

INSTALLAZIONE APPLICATION

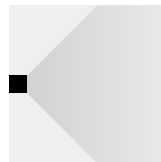

Parete/Wall

DISEGNI TECNICI TECHNICAL DRAWINGS

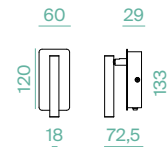

REGOLAZIONI ADJUSTABILITY



Dumbo flex nero/Black Dumbo flex



BLOC

LED
CRI >80
PF 0.5

Sanan
>80
0.5

CODE	FINISHING	WATT	LUMEN	KELVIN	DRIVER
30378	300mA 39V	6W	540	3000K	350mA 15V
30377	300mA 39V	12W	1080	3000K	300mA 39V
30376	300mA 39V	18W	1620	3000K	300mA 62V

INSTALLAZIONE APPLICATION



Parete/Wall

DISEGNI TECNICI TECHNICAL DRAWINGS

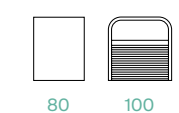

30378

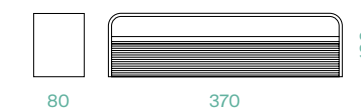

30377

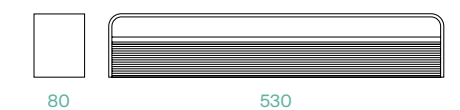

30376

BLOC

Apparecchio a parete LED integrato
Illuminazione diretta ed indiretta
Corpo in alluminio verniciato
Driver integrato

Wall fitting with built-in LED
Direct and indirect lighting
Painted aluminium body
Built-in driver



PROFILES



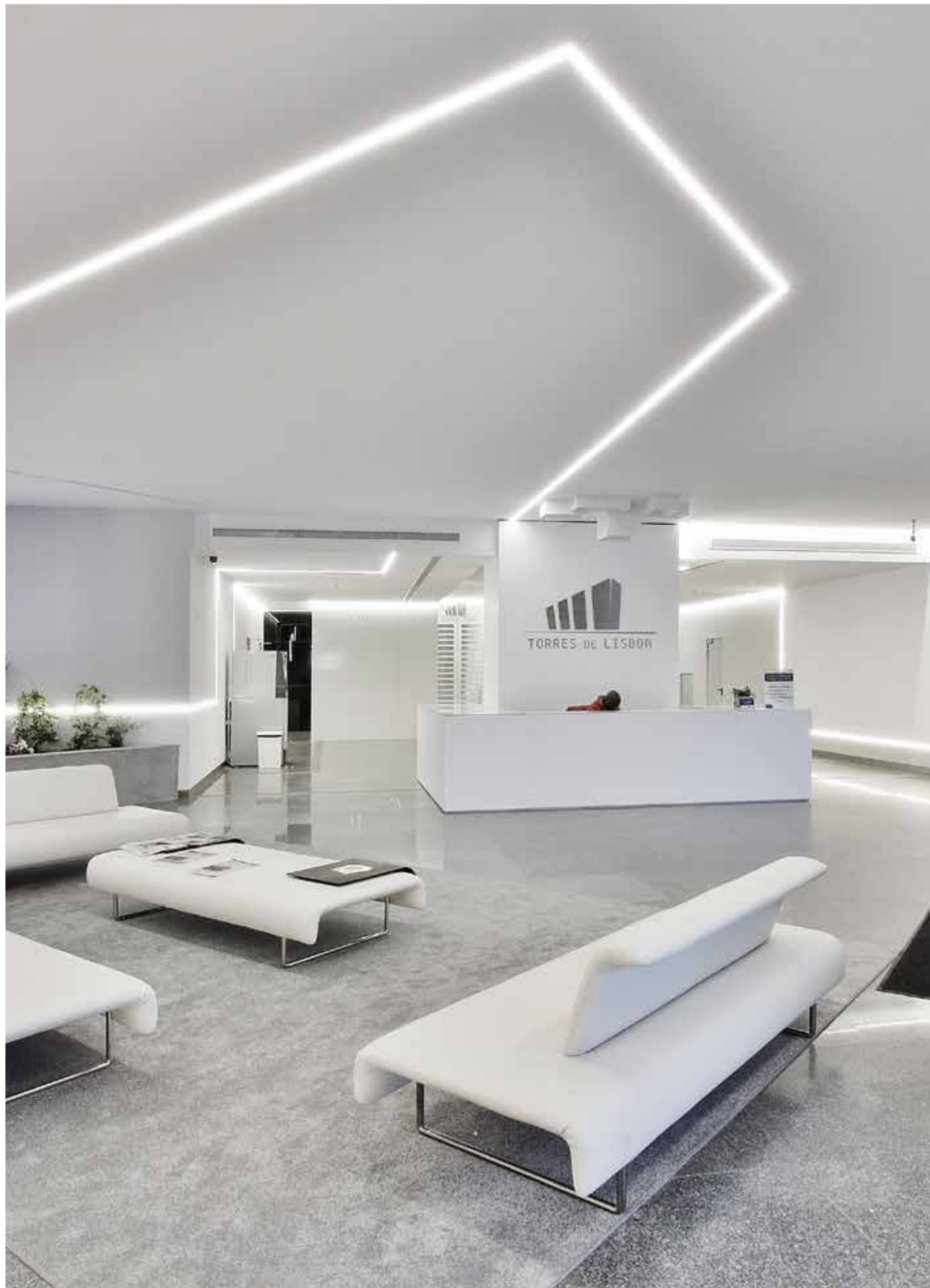

Torre de Lisboa



WALL INCASSO

CODE	FINISHING	DESCRIPTION
21388	Bianco/White	Profilo 2 mt./Profile 2 mt.

INSTALLAZIONE APPLICATION

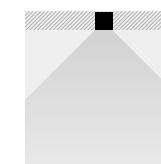

Incasso/Recessed

DISEGNI TECNICI TECHNICAL DRAWINGS

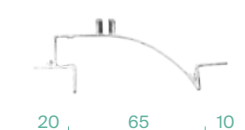

ACCESSORI ACCESSORIES

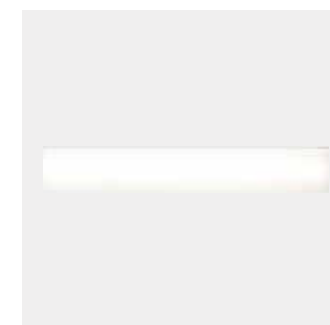

21301

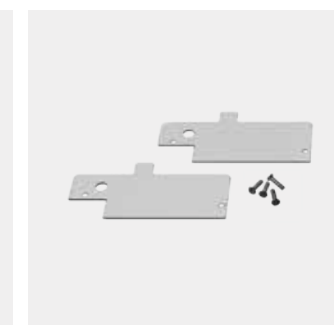

21389

CODE	FINISHING	DESCRIPTION
21301	Opale/Opal	Schermo 2 mt./Diffuser 2mt.
21389	Bianco/White	Kit 4 viti + 2 testate di chiusura/ 4 screws + 2 end caps kit

WALL INCASSO

Profilo architettonico in alluminio estruso verniciato bianco
Montaggio a raso senza cassaforme
Wall-washer o segnapasso a seconda del montaggio
Schermo in PC opale
Ampia gamma di potenze

Extruded aluminium architectural profile in white finishing
Trimless mounting without any framework
Wall-washer or wall-step depending on installation
Opal PC diffuser
Wide range of wattages available

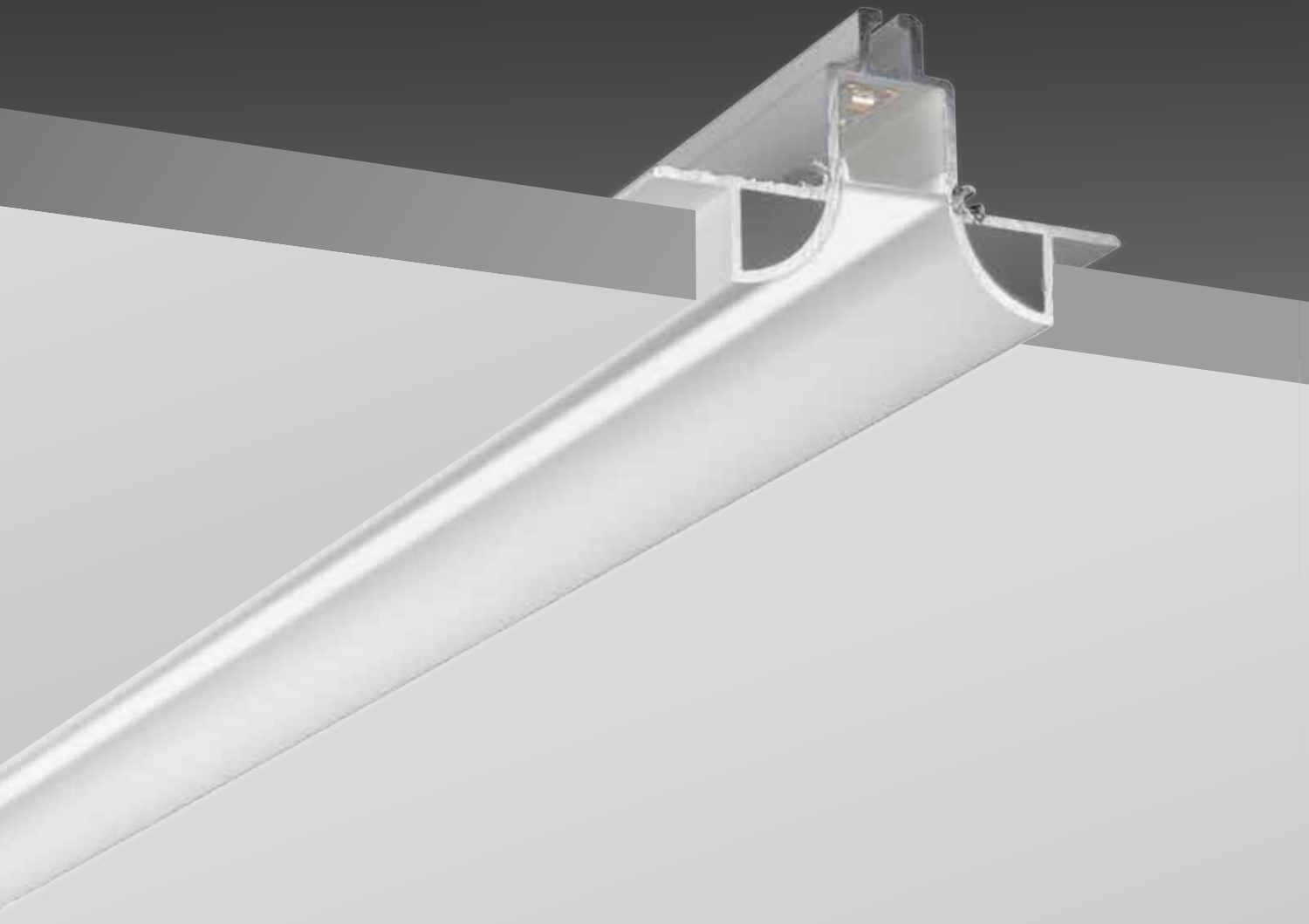

ONDA INCASSO

CODE	FINISHING	DESCRIPTION
21385	Bianco/White	Profilo 2 mt./Profile 2 mt.

INSTALLAZIONE APPLICATION

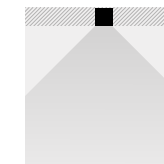

Incasso/Recessed

DISEGNI TECNICI TECHNICAL DRAWINGS

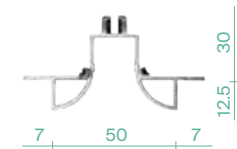

ACCESSORI ACCESSORIES



21387



21386

CODE	FINISHING	DESCRIPTION
21387	Opale/Opal	Schermo 2 mt./Diffuser 2mt.
21386	Bianco/White	Kit 4 viti + 2 testate di chiusura/ 4 screws + 2 end caps kit

ONDA INCASSO

Profilo architettonico in alluminio estruso verniciato bianco
Montaggio a raso senza cassaforme
Illuminazione generale o d'accento a seconda del montaggio
Schermo in PC opale
Ampia gamma di potenze

Extruded aluminium architectural profile in white finishing
Trimless mounting without any framework
General or accent lighting depending on installation
Opal PC diffuser
Wide range of wattages available



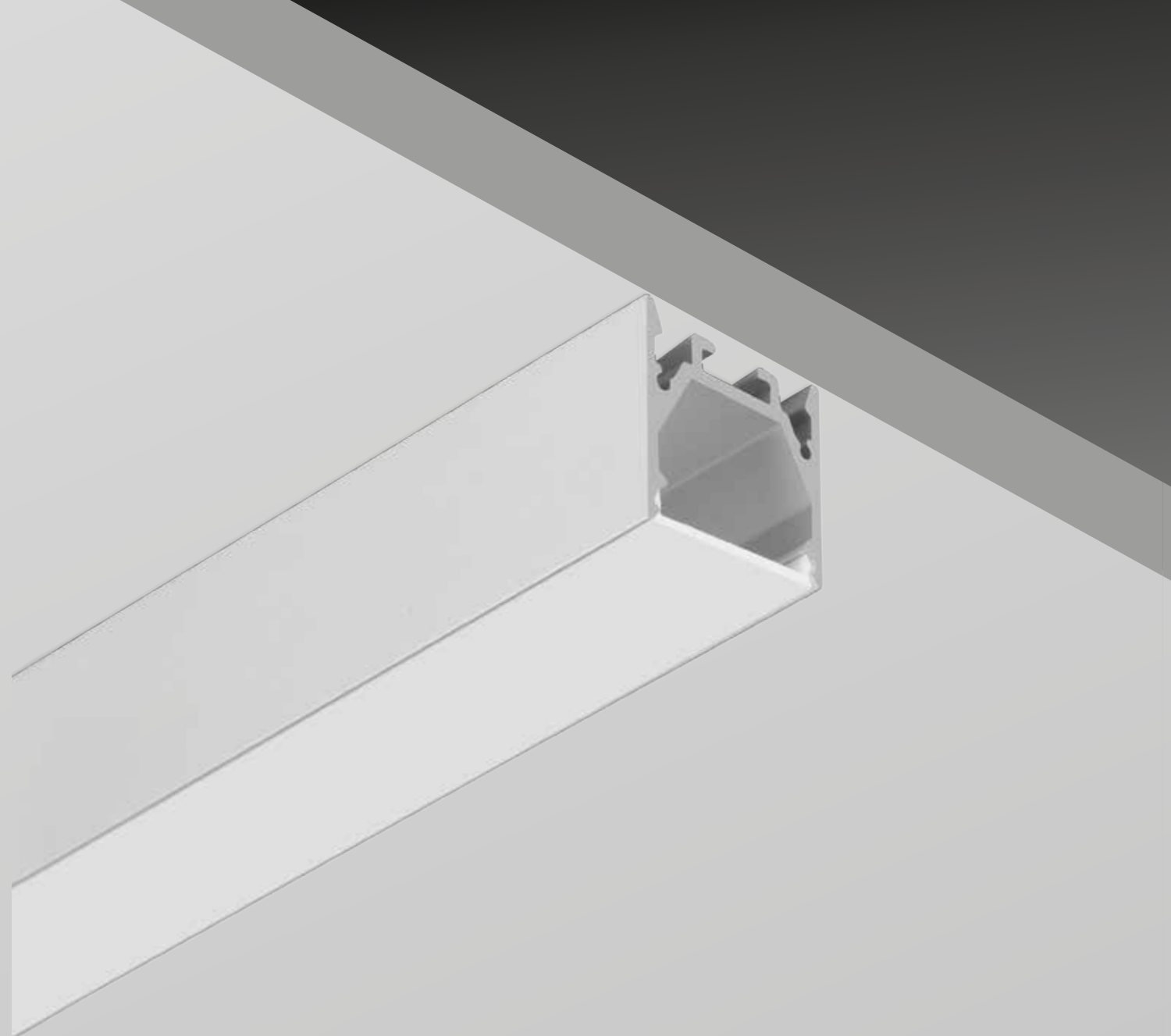

LINE_EVO SOFFITTO

Profilo in alluminio estruso anodizzato
Montaggio a soffitto
Illuminazione generale o d'accento
a seconda del montaggio
Schermo in PC opale
Ampia gamma di potenze

Extruded anodized aluminium profile
Ceiling mounting
General or accent lighting depending
on installation
Opal PC diffuser
Wide range of wattages available



LINE_EVO SOFFITTO

CODE	FINISHING	DESCRIPTION
11911	Alluminio/Aluminium	Profilo 2 mt/Profile 2 mt
11912	Bianco/White	Profilo 2 mt/Profile 2 mt
11913	Nero/Black	Profilo 2 mt/Profile 2 mt

INSTALLAZIONE APPLICATION

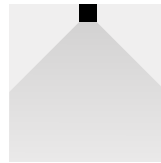

Soffitto/Ceiling

DISEGNI TECNICI TECHNICAL DRAWINGS

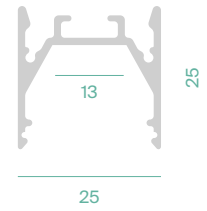

ACCESSORI ACCESSORIES

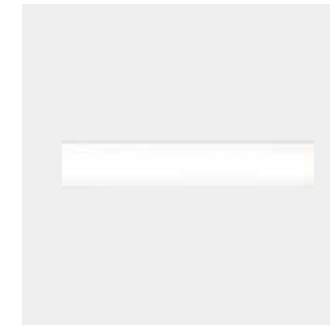

11914



11915

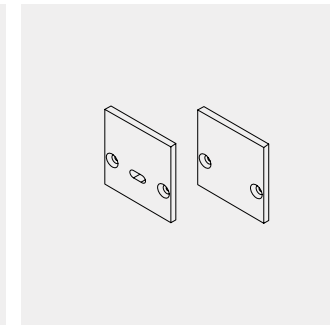

11916, 11917, 11918

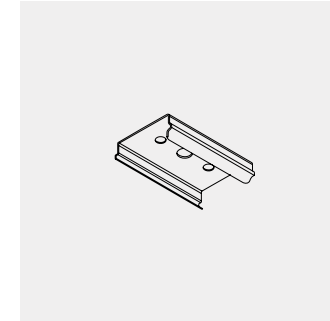

11919

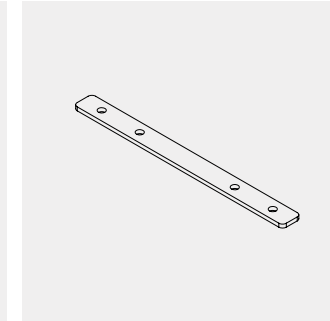

11920

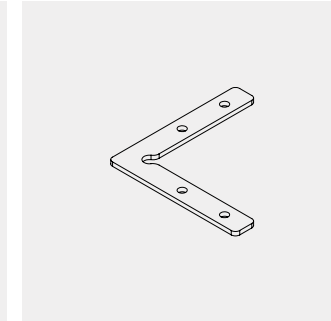

11921

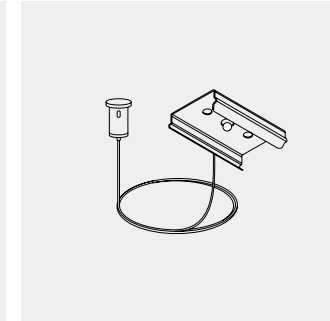

11922

CODE	FINISHING	DESCRIPTION
11914	Opale/Opal	Schermo 2 mt/Diffuser 2mt
11915	Nero/Black	Schermo 2 mt/Diffuser 2mt
11916	Alluminio/ Aluminium	Kit 4 viti + 2 testate/ 4 screws + 2 end caps kit
11917	Bianco/White	Kit 4 viti + 2 testate/ 4 screws + 2 end caps kit
11918	Nero/Black	Kit 4 viti + 2 testate/ 4 screws + 2 end caps kit
11919	n/a	Kit 2 staffe per soffitto 2 ceiling fixing brackets kit
11920	n/a	Congiunzione lineare/Linear junction
11921	n/a	Congiunzione 90°/90° junction
11922	n/a	Kit 2 sospensioni con cavo 3mt./ 2 suspension kit with 3m steel cable

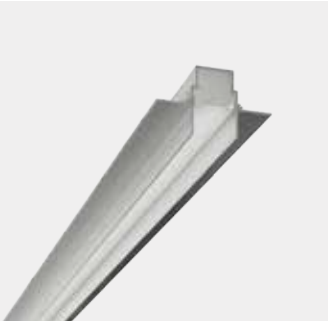
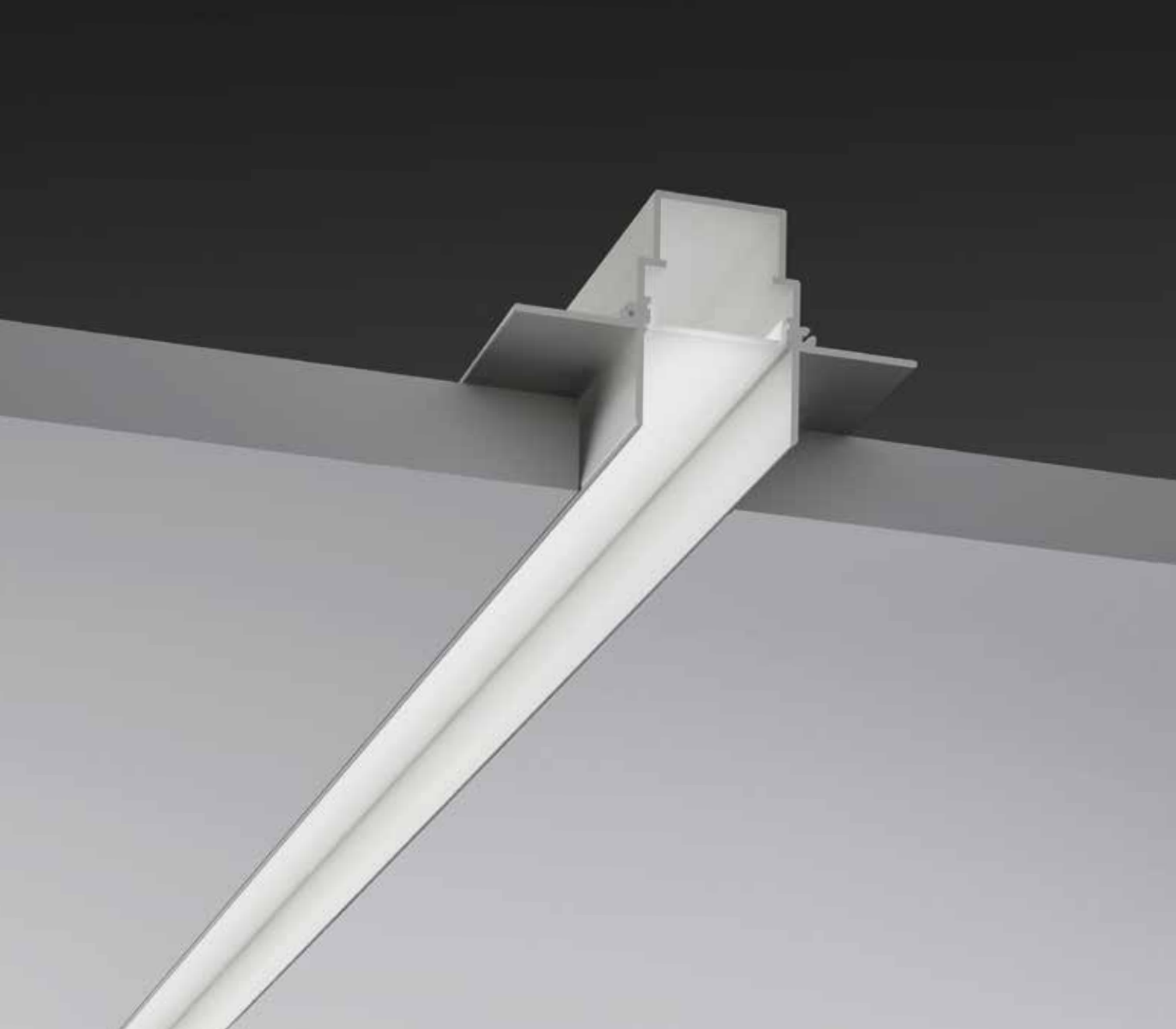

**LINE DEEP
INCASSO**

CODE	FINISHING	DESCRIPTION
11910	Bianco/White	Profilo 2 mt / Profile 2 mt

**INSTALLAZIONE
APPLICATION**

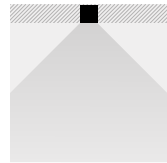

Incasso/Recessed

**DISEGNI TECNICI
TECHNICAL DRAWINGS**

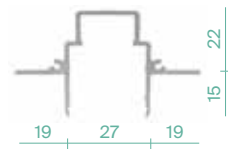

**ACCESSORI
ACCESSORIES**



21303

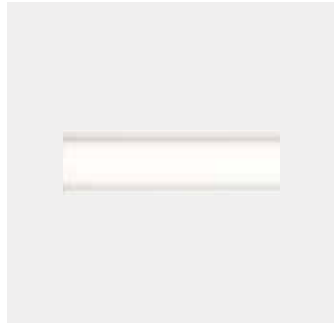

21304

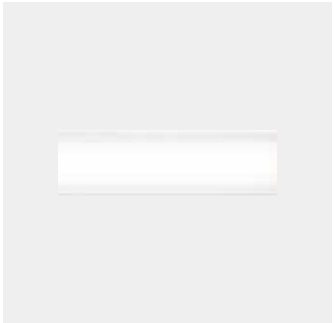

21305

CODE	FINISHING	DESCRIPTION
21303	Trasparente/ Trasparente	Schermo 2 mt / Diffuser 2mt
21304	Satinato/Frosted	Schermo 2 mt / Diffuser 2mt
21305	Opale/Opal	Schermo 2 mt / Diffuser 2mt

**LINE DEEP
INCASSO**

Profilo in alluminio estruso anodizzato
Montaggio a raso senza cassaforme
Illuminazione generale o d'accento a seconda
del montaggio
Schermo rientrante in PC opale
Ampia gamma di potenze

Extruded anodized aluminium profile
Trimless mounting without any framework
General or accent lighting depending on installation
Opal PC recess diffuser
Wide range of wattages available

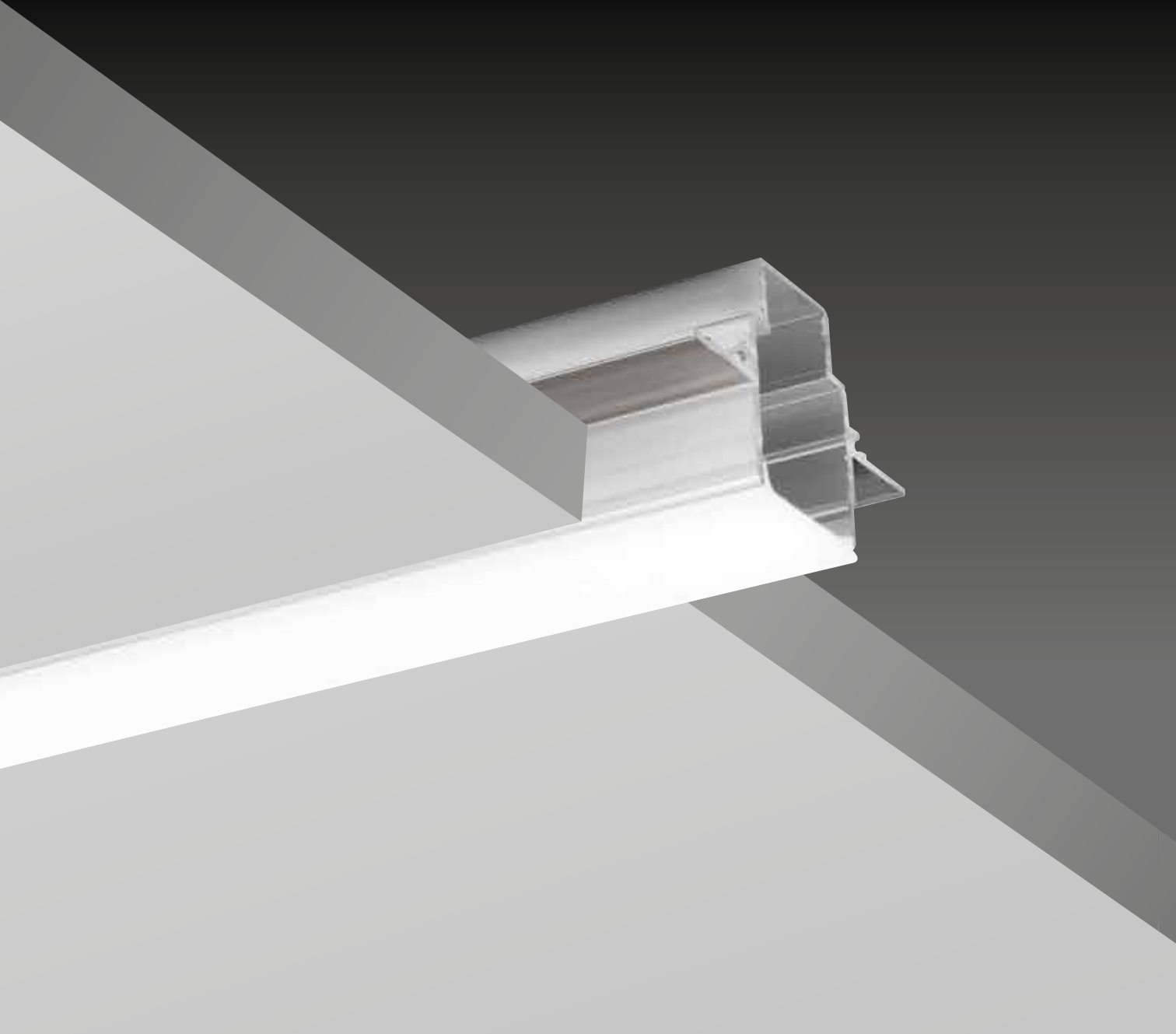

LINE INCASSO

Profilo in alluminio estruso anodizzato
 Montaggio a raso senza cassaforme
 Illuminazione generale o d'accento a seconda
 del montaggio
 Schermo in PC opale
 Ampia gamma di potenze

Extruded anodized aluminium profile
 Trimless mounting without any framework
 General or accent lighting depending on installation
 Opal PC diffuser
 Wide range of wattages available



LINE INCASSO

CODE	FINISHING	DESCRIPTION
11906	Alluminio/Aluminium	Profilo 2 mt / Profile 2 mt

INSTALLAZIONE APPLICATION

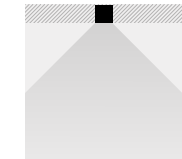

Incasso/Recessed

DISEGNI TECNICI TECHNICAL DRAWINGS

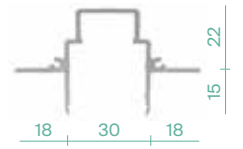

ACCESSORI ACCESSORIES

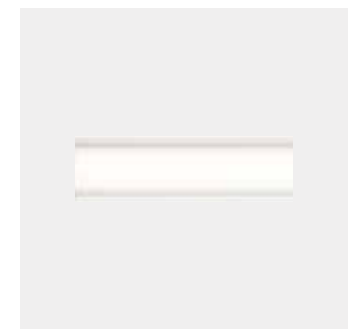

11675



13518

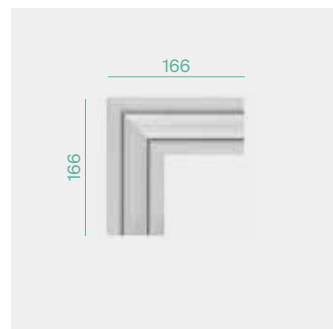

13570

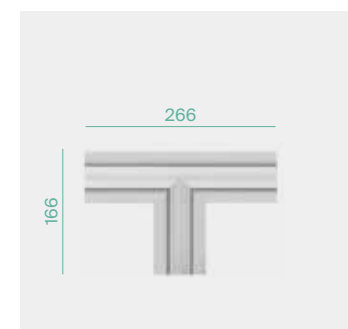

13571

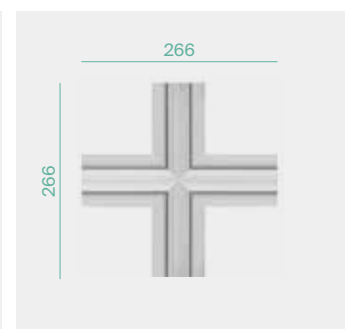

13572

CODE	FINISHING	DESCRIPTION
11675	Satinato-opale/Opal-frosted	Schermo PC 2 mt./PC diffuser 2mt.
13518	Alluminio/Aluminium	Testata per laterizio/ End-cap brick surface
13570	Alluminio/Aluminium	Giunto "L"/L-joint
13571	Alluminio/Aluminium	Giunto "T"/T-joint
13572	Alluminio/Aluminium	Giunto "X"/X-joint

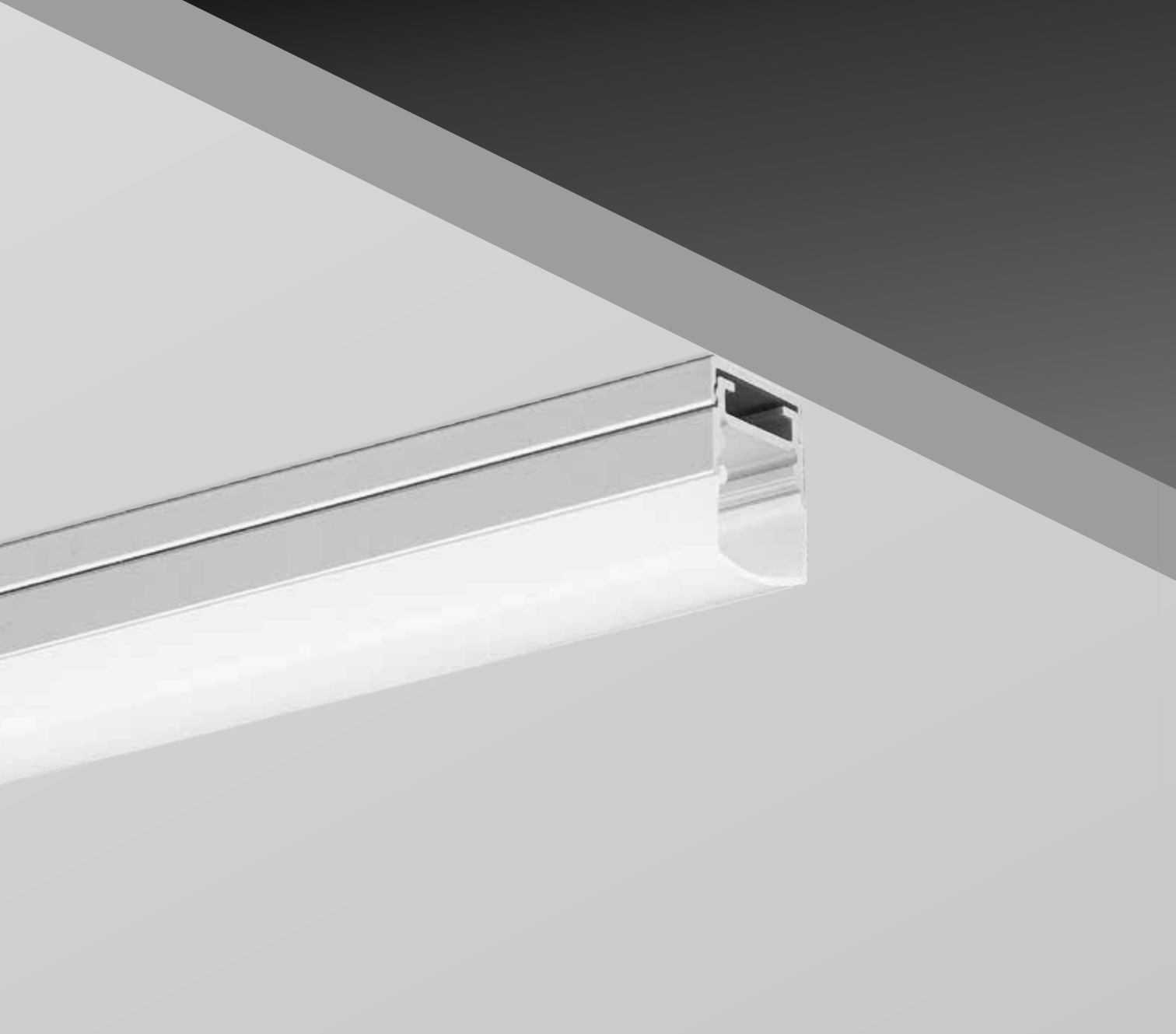

DOUBLE SOFFITTO

CODE	FINISHING	DESCRIPTION
21472	Alluminio/Aluminium	Profilo 2 mt/Profile 2 mt
21473	Bianco/White	Profilo 2 mt/Profile 2 mt

INSTALLAZIONE APPLICATION

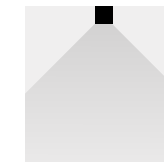

Soffitto/Ceiling

DISEGNI TECNICI TECHNICAL DRAWINGS

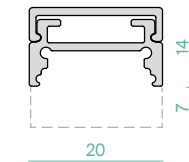

ACCESSORI ACCESSORIES



21476 - 21477



21474

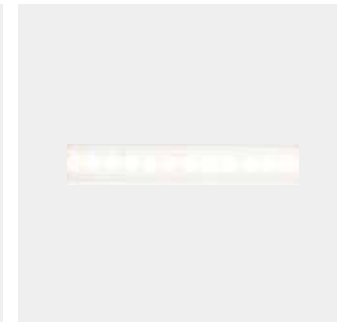

21475

CODE	FINISHING	DESCRIPTION
21474	Opale/Opal	Schermo 2 mt./Diffuser 2mt.
21475	Satinato/Frosted	Schermo 2 mt./Diffuser 2mt.
21476	Alluminio/Aluminium	Kit 4 viti + 2 testate / 4 screws + 2 end caps kit
21477	Bianco/White	Kit 4 viti + 2 testate / 4 screws + 2 end caps kit

DOUBLE SOFFITTO

Profilo in alluminio estruso anodizzato o verniciato
 Montaggio a soffitto
 Illuminazione generale o d'accento a seconda del montaggio
 Possibilità schermo opale o satinato
 Ampia gamma di potenze

Extruded aluminium profile anodized or painted
 Ceiling mounting
 General or accent lighting depending on installation
 Opal or frosted diffuser available
 Wide range of wattages available

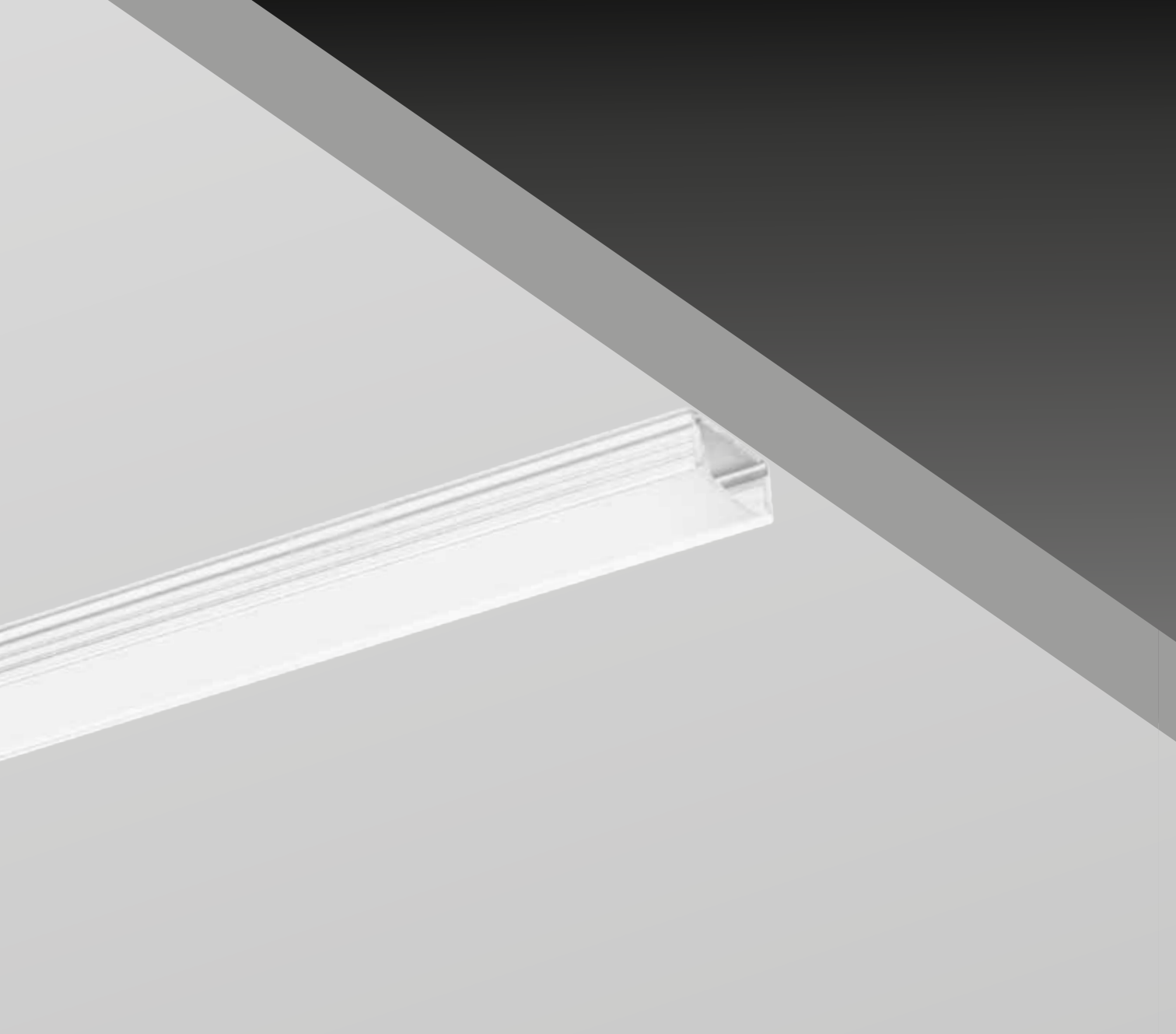

PR1 . PR1_DEEP

SOFFITTO

Profilo in alluminio estruso anodizzato o verniciato
Montaggio a soffitto
Illuminazione generale o d'accento
a seconda del montaggio
Possibilità schermo opale, satinato o trasparente
Ampia gamma di potenze

Extruded aluminium profile anodized or painted
Ceiling mounting
General or accent lighting depending on installation
Opal, frosted or transparent diffuser available
Wide range of wattages available



PR1 SOFFITTO

CODE	FINISHING	DESCRIPTION
21048	Alluminio/Aluminium	Profilo 2 mt/Profile 2 mt
21376	Bianco/White	Profilo 2 mt/Profile 2 mt

INSTALLAZIONE APPLICATION

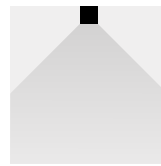

Soffitto/Ceiling

DISEGNI TECNICI TECHNICAL DRAWINGS

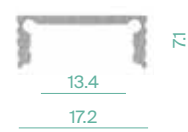

PR1_DEEP SOFFITTO

CODE	FINISHING	DESCRIPTION
21494	Alluminio/Aluminium	Profilo 2 mt/Profile 2 mt
21495	Bianco/White	Profilo 2 mt/Profile 2 mt

INSTALLAZIONE APPLICATION

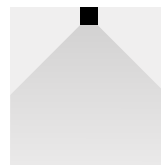

Soffitto/Ceiling

DISEGNI TECNICI TECHNICAL DRAWINGS

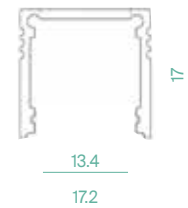

ACCESSORI ACCESSORIES



21052

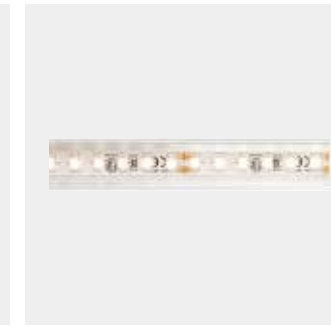

21051

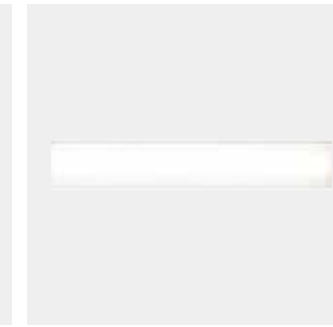

21301



21053 - 21378

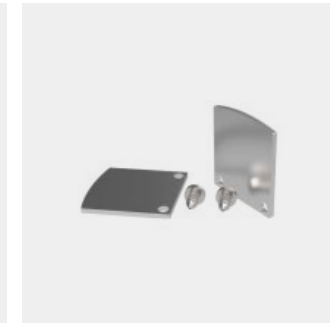

21496 - 21497



21054 - 21379

CODE	FINISHING	DESCRIPTION
21052	Satinato/Frosted	Schermo 2 mt. per PR1, PR1_DEEP/ Diffuser 2mt. for PR1, PR1_DEEP
21051	Trasparente/ Trasparente	Schermo 2 mt. per PR1, PR1_DEEP/ Diffuser 2mt. for PR1, PR1_DEEP
21301	Opale/Opal	Schermo 2 mt. per PR1, PR1_DEEP/ Diffuser 2mt. for PR1, PR1_DEEP
21053	Alluminio/ Aluminium	Kit 4 viti + 2 testate per PR1/ 4 screws + 2 end caps kit for PR1
21378	Bianco/White	Kit 4 viti + 2 testate per PR1/ 4 screws + 2 end caps kit for PR1
21496	Alluminio/ Aluminium	Kit 4 viti + 2 testate per PR1_DEEP/ 4 screws + 2 end caps kit for PR1_DEEP
21497	Bianco/White	Kit 4 viti + 2 testate per PR1_DEEP/ 4 screws + 2 end caps kit for PR1_DEEP
21054	Alluminio/ Aluminium	Kit 2 staffe fissaggio per PR1, PR1_DEEP/ 2 fixing brackets kit for PR1, PR1_DEEP
21379	Bianco/White	Kit 2 staffe fissaggio per PR1, PR1_DEEP/ 2 fixing brackets kit for PR1, PR1_DEEP

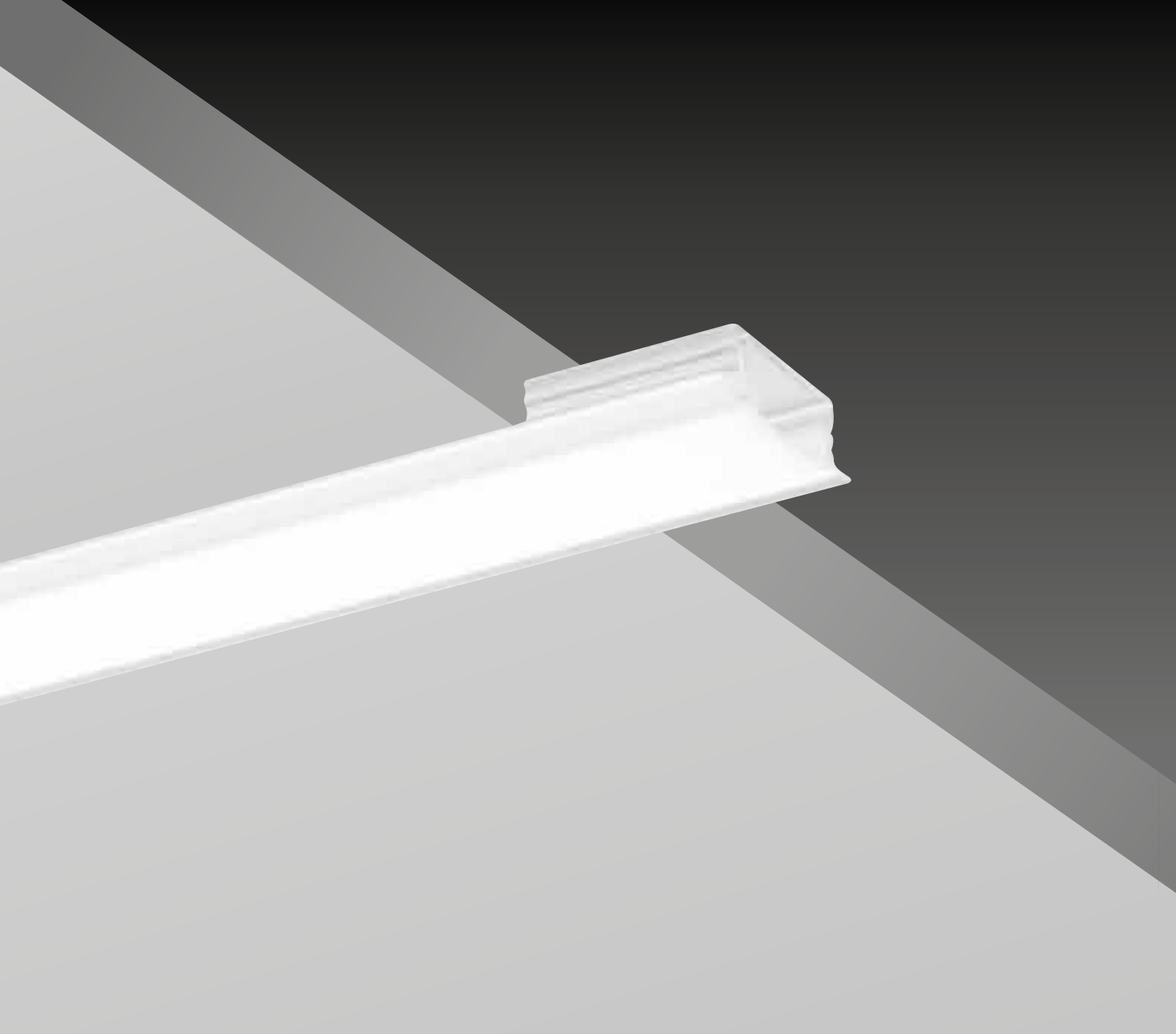

PR2 . PR2_DEEP INCASSO

Profilo in alluminio estruso anodizzato o verniciato
Montaggio ad incasso
Illuminazione generale o d'accento
a seconda del montaggio
Possibilità schermo opale, satinato o trasparente
Ampia gamma di potenze

Extruded aluminium profile anodized or painted
Recessed mounting
General or accent lighting depending on installation
Opal, frosted or transparent diffuser available
Wide range of wattages available



PR2 INCASSO

CODE	FINISHING	DESCRIPTION
21049	Alluminio/Aluminium	Profilo 2 mt. /Profile 2 mt.
21377	Bianco/White	Profilo 2 mt. PR2 incasso/ Profile 2 mt. PR2 recessed

INSTALLAZIONE APPLICATION

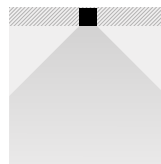

Incasso/Recessed

DISEGNI TECNICI TECHNICAL DRAWINGS

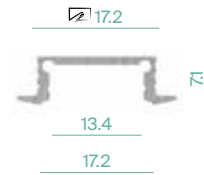

PR2_DEEP INCASSO

CODE	FINISHING	DESCRIPTION
21498	Alluminio/Aluminium	Profilo 2 mt/Profile 2 mt
21499	Bianco/White	Profilo 2 mt/Profile 2 mt

INSTALLAZIONE APPLICATION

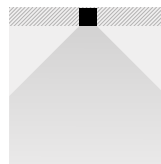

Incasso/Recessed

DISEGNI TECNICI TECHNICAL DRAWINGS

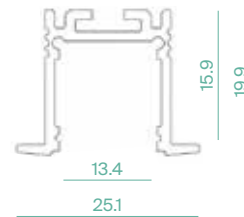

ACCESSORI ACCESSORIES



21052

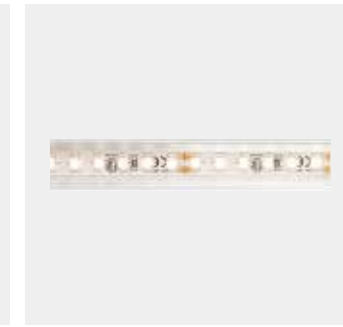

21051

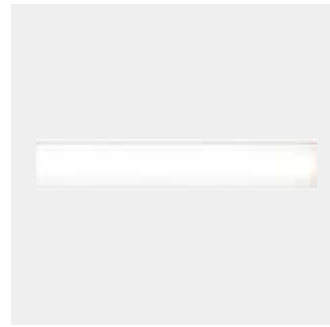

21301



21053 - 21378



21496 - 21497



21054 - 21379



21500

CODE	FINISHING	DESCRIPTION
21052	Satinato/Frosted	Schermo 2 mt. per PR2, PR2_DEEP/Diffuser 2mt. for PR2, PR2_DEEP
21051	Trasparente/ Trasparente	Schermo 2 mt. per PR2, PR2_DEEP/Diffuser 2mt. for PR2, PR2_DEEP
21301	Opale/Opal	Schermo 2 mt. per PR2, PR2_DEEP/Diffuser 2mt. for PR2, PR2_DEEP
21053	Alluminio/ Aluminium	Kit 4 viti + 2 testate per PR2/ 4 screws + 2 end caps kit for PR2
21378	Bianco/White	Kit 4 viti + 2 testate per PR2/ 4 screws + 2 end caps kit for PR2
21496	Alluminio/ Aluminium	Kit 4 viti + 2 testate per PR2_DEEP/ 4 screws + 2 end caps kit for PR2_DEEP
21497	Bianco/White	Kit 4 viti + 2 testate per PR2_DEEP/ 4 screws + 2 end caps kit for PR2_DEEP
21054	Alluminio/ Aluminium	Kit 2 staffe fissaggio per PR2, PR2_DEEP/ 2 fixing brackets kit for PR2, PR2_DEEP
21379	Bianco/White	Kit 2 staffe fissaggio per PR2, PR2_DEEP/ 2 fixing brackets kit for PR2, PR2_DEEP
21500	n/a	Molla per PR2_DEEP 2pz/Spring for PR2_DEEP 2pcs

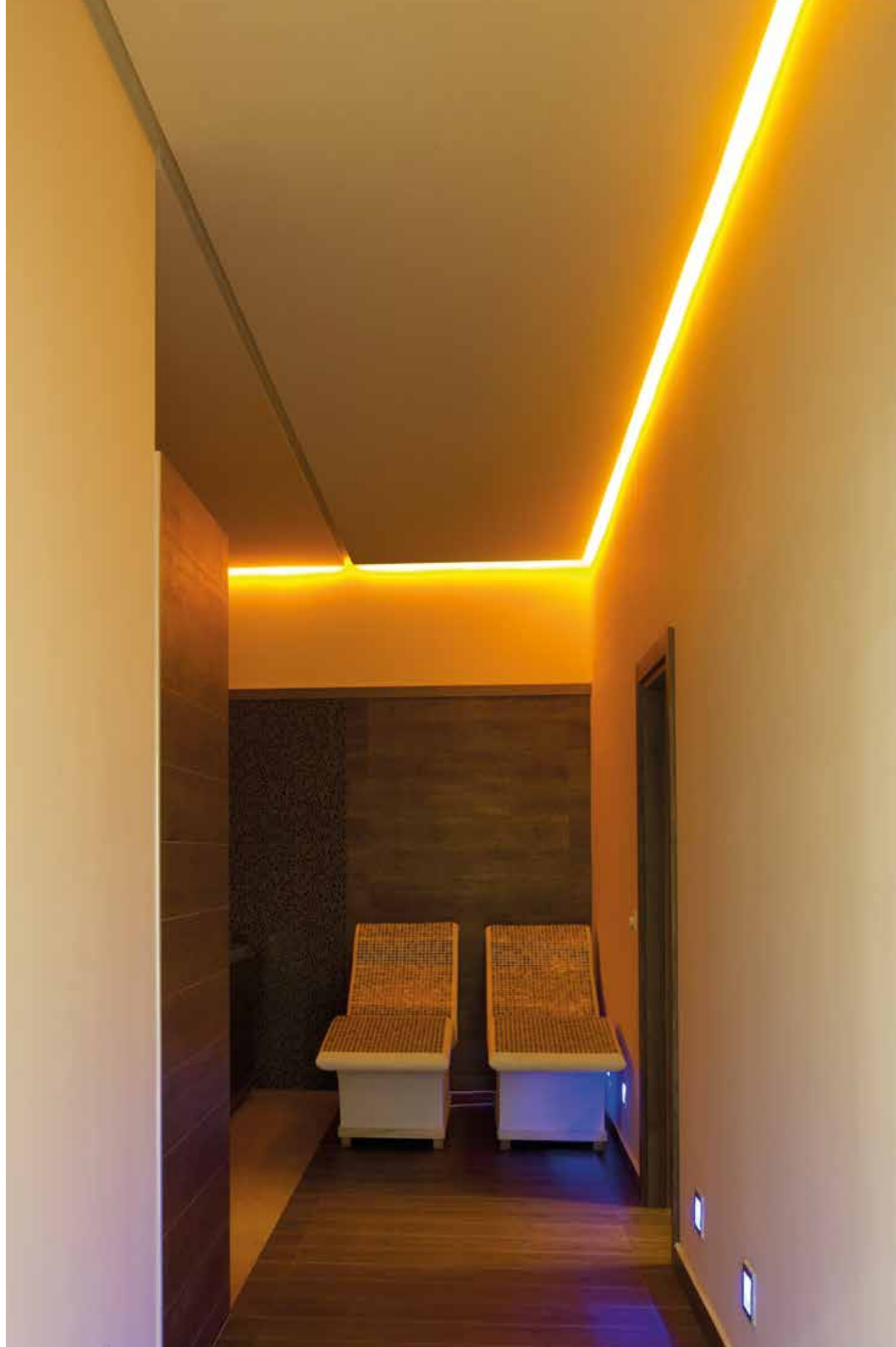

PR3_EVO ANGOLO

Profilo in alluminio estruso anodizzato o verniciato
Montaggio ad angolo
Illuminazione generale o d'accento
a seconda del montaggio
Possibilità schermo opale o satinato
Ampia gamma di potenze

Extruded aluminium profile anodized
or painted corner mounting
General or accent lighting depending on installation
Opal or frosted diffuser available
Wide range of wattages available



PR3_EVO
ANGOLO

CODE	FINISHING	DESCRIPTION
21440	Alluminio/Aluminium	Profilo 2 mt./Profile 2 mt.
21441	Bianco/White	Profilo 2 mt./Profile 2 mt.

INSTALLAZIONE
APPLICATION

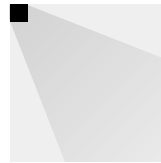

Angolo/Corner

DISEGNI TECNICI
TECHNICAL DRAWINGS

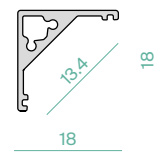

ACCESSORI
ACCESSORIES



21442

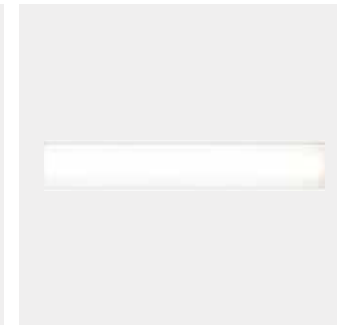

21443

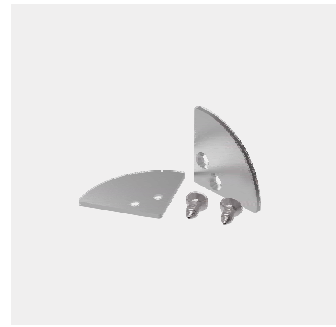

21444 - 21445



21446 - 21447

CODE	FINISHING	DESCRIPTION
21442	Satinato/Frosted	Schermo 2 mt. per PR3 EVO/ Diffuser 2mt. for PR3 EVO
21443	Opale/Opal	Schermo 2 mt. per PR3 EVO/ Diffuser 2mt. for PR3 EVO
21444	Alluminio/Aluminium	Kit 4 viti + 2 testate per PR3 EVO/ 4 screws + 2 end caps kit for PR3 EVO
21445	Bianco/White	Kit 4 viti + 2 testate per PR3 EVO/ 4 screws + 2 end caps kit for PR3 EVO
21446	Alluminio/Aluminium	Kit 2 staffe fissaggio per PR3 EVO/ 2 fixing brackets kit for PR3 EVO
21447	Bianco/White	Kit 2 staffe fissaggio per PR3 EVO/ 2 fixing brackets kit for PR3 EVO

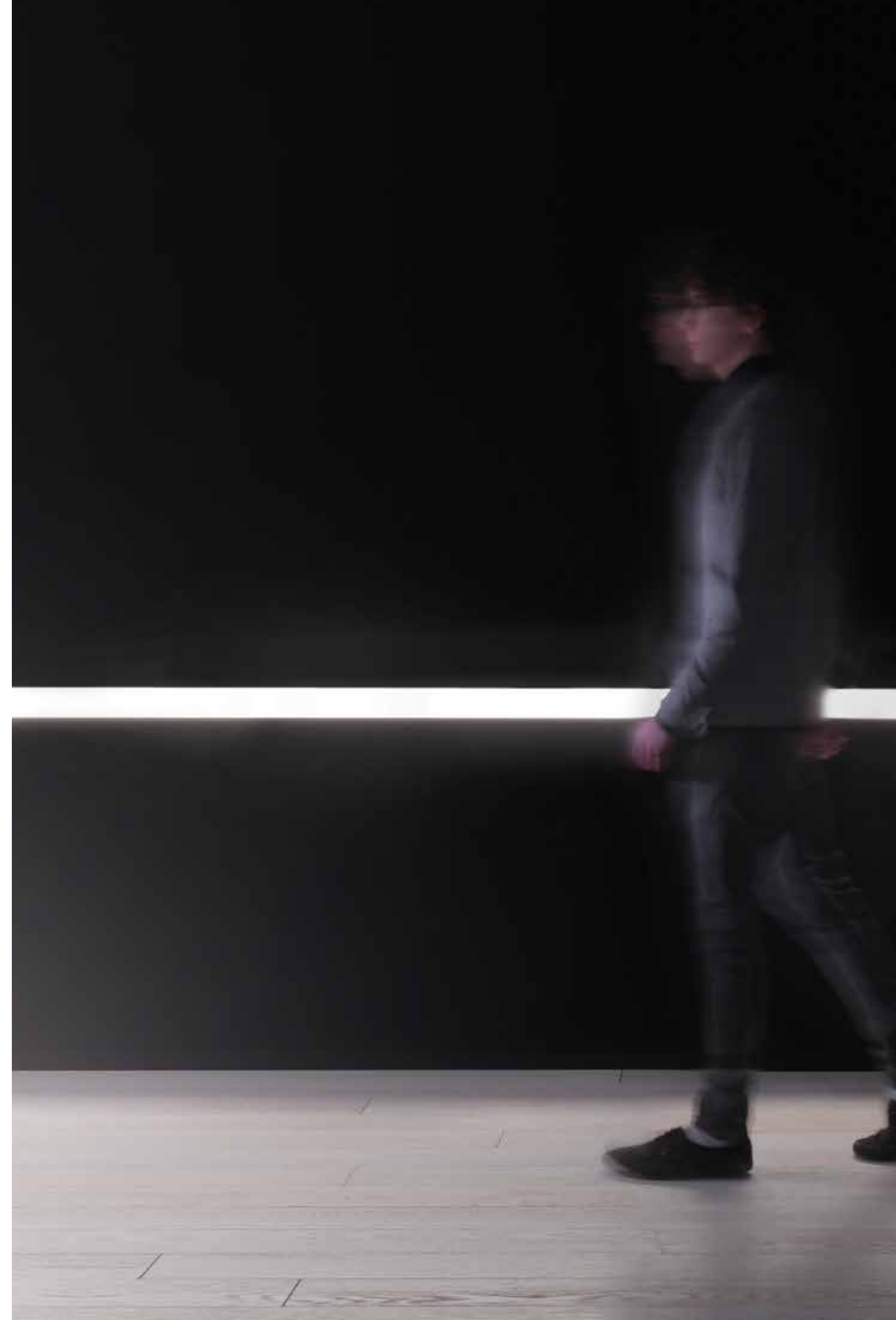
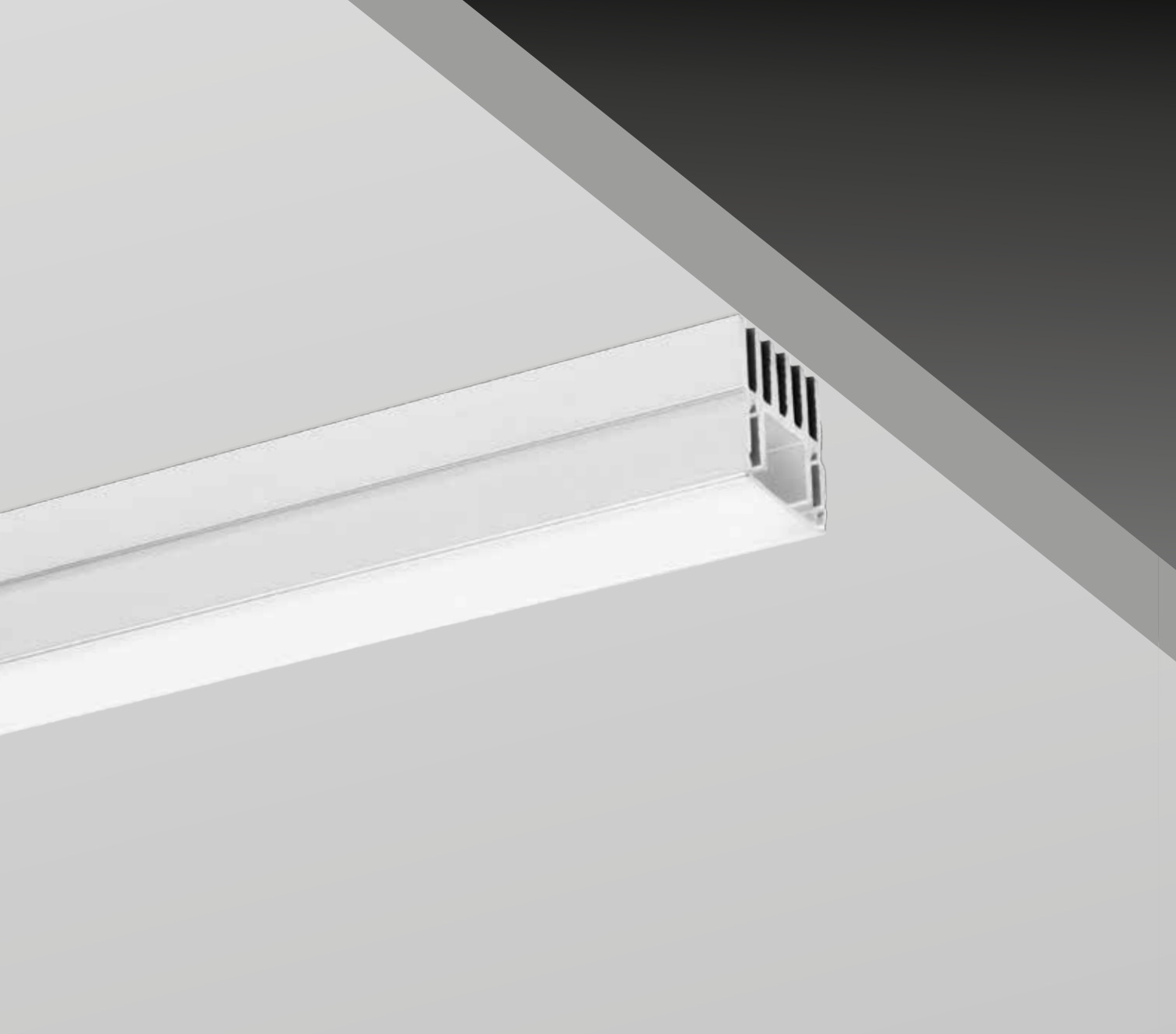

PR4 SOFFITTO

Profilo in alluminio estruso anodizzato o verniciato
Montaggio a soffitto
Illuminazione generale o d'accento
a seconda del montaggio
Possibilità schermo opale, satinato o trasparente
Ampia gamma di potenze

Extruded aluminium profile anodized or painted
Ceiling mounting
General or accent lighting depending on installation
Opal, frosted or transparent diffuser available
Wide range of wattages available

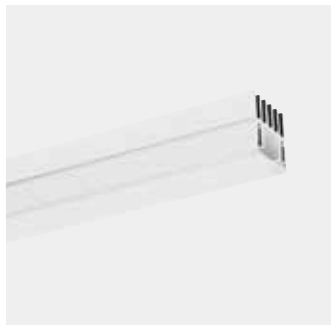

PR4 SOFFITTO

CODE	FINISHING	DESCRIPTION
21302	Alluminio/Aluminium	Profilo 2 mt. PR4 superficie/Profile 2 mt. PR4 surface
21382	Bianco/White	Profilo 2 mt. PR4 superficie/Profile 2 mt. PR4 surface

INSTALLAZIONE APPLICATION

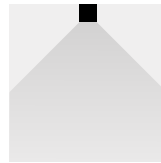

Soffitto/Ceiling

DISEGNI TECNICI TECHNICAL DRAWINGS

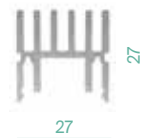

ACCESSORI ACCESSORIES



21304

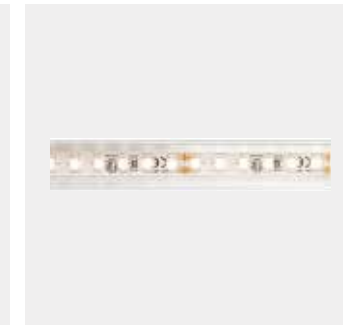

21303

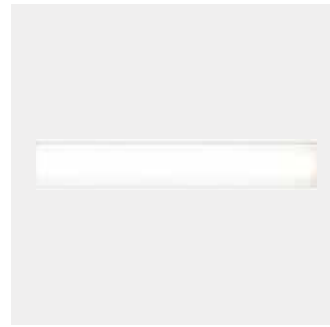

21305



21306 - 21384



21307 - 21383

CODE	FINISHING	DESCRIPTION
21304	Satinato/Frosted	Schermo 2 mt. per PR4/ Diffuser 2mt. for PR4
21303	Trasparente/ Trasparente	Schermo 2 mt. per PR4/ Diffuser 2mt. for PR4
21305	Opale/Opal	Schermo 2 mt. per PR4/ Diffuser 2mt. for PR4
21306	Alluminio/ Aluminium	Kit 4 viti + 2 testate di chiusura per PR4/ 4 screws + 2 end caps kit for PR4
21384	Bianco/White	Kit 4 viti + 2 testate di chiusura per PR4/ 4 screws + 2 end caps kit for PR4
21307	Alluminio/ Aluminium	Kit 4 staffe fissaggio per PR4/ 4 fixing brackets kit for PR4
21383	Bianco/White	Kit 4 staffe fissaggio per PR4/ 4 fixing brackets kit for PR4

OUTDOOR

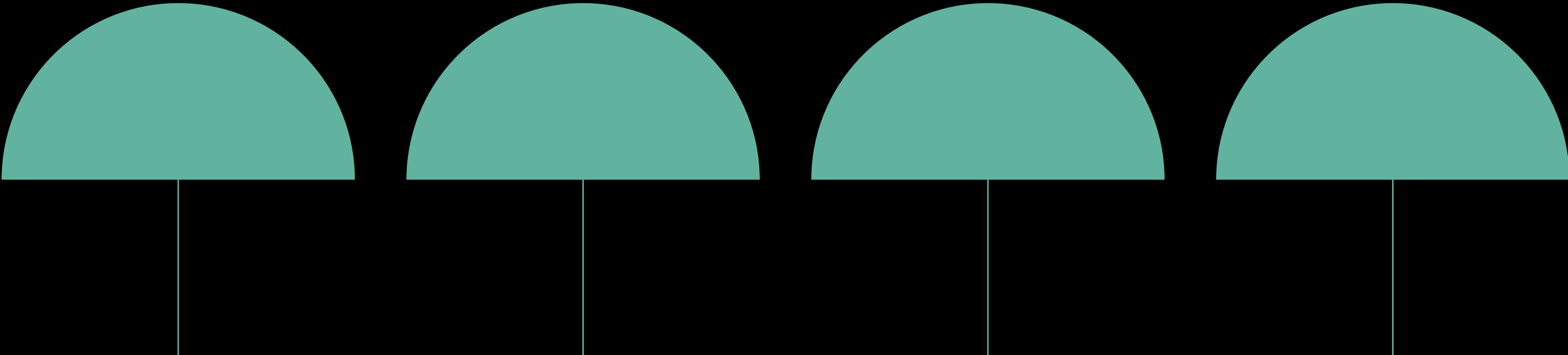



Moonlight



Titano_EVO parete

Accento bianco/White Accento



TITANO EVO

Apparecchio LED integrato
monoemissione e bi-emissione
Corpo in alluminio pressofuso verniciato
e ottica brillantata
Driver integrato

Built-in LED single
and double-sided emission
Painted die-cast aluminium body
with multifaceted reflector
Built-in driver

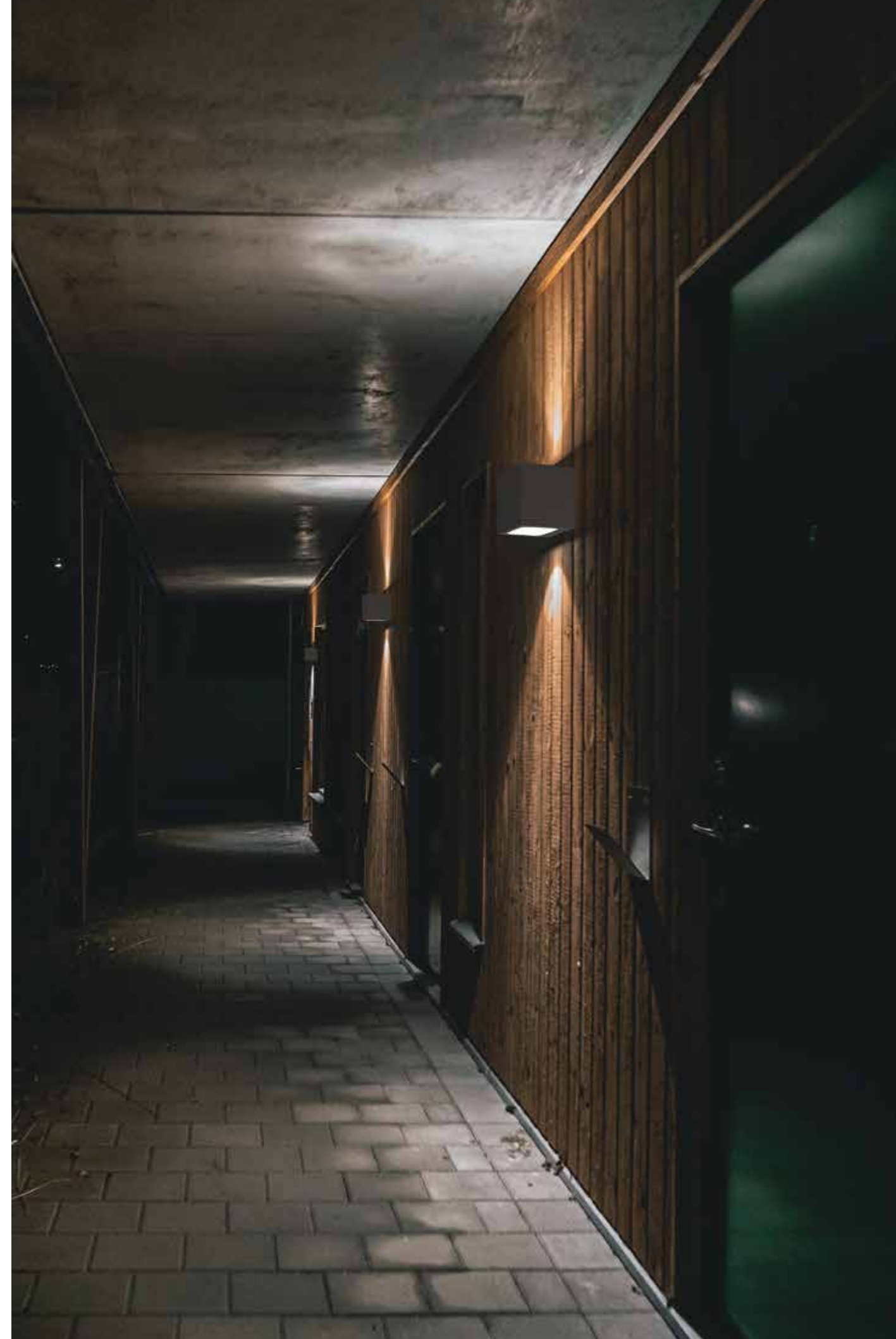

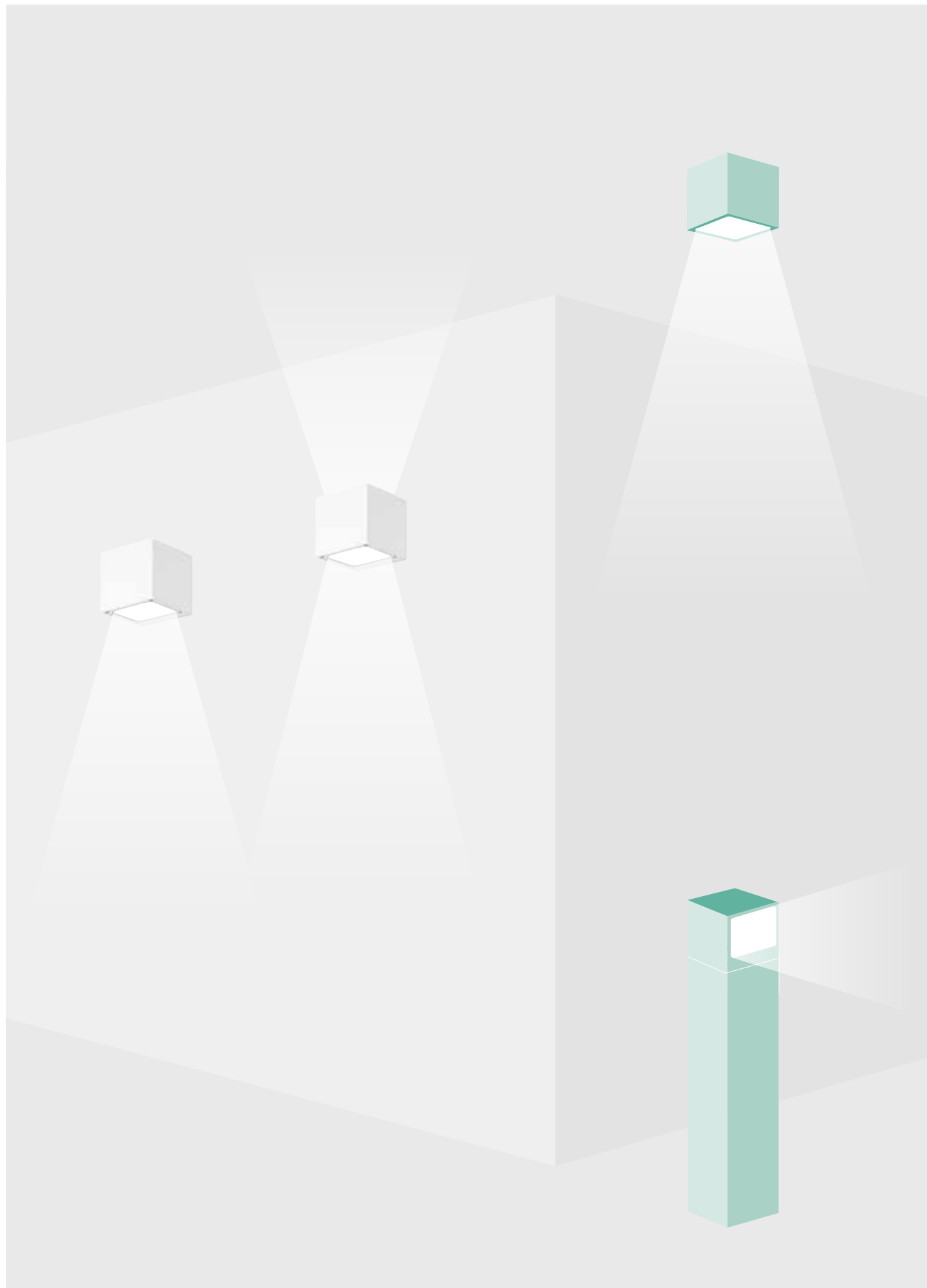

VERSATILE

Grazie alle sue configurazioni, Titano_Evo permette il montaggio a parete e a paletto. Infine, con la versione a soffitto, copre tutte le possibili installazioni in ambito residenziale.

VERSATILE

Thanks to its configuration Titano_Evo can be mounted either as wall or bollard fitting. In addition to that, the ceiling version covers all possible applications requested in a residential installation.





TITANO EVO
PARETE
MONO-EMISSIONE

LED
CRI >80
PF 0.54 (6W)
0.91 (10W)

CODE	FINISHING	WATT	LUMEN	BEAM	KELVIN	DRIVER
43126	Bianco/White	6W	400	45°	3000K	500mA, 23V
43130	Antracite/ Anthracite	6W	400	45°	3000K	500mA, 23V
43127	Bianco/White	6W	400	45°	5000K	500mA, 23V
43131	Antracite/ Anthracite	6W	400	45°	5000K	500mA, 23V
43128	Bianco/White	10W	600	60°	3000K	250mA, 58V
43132	Antracite/ Anthracite	10W	600	60°	3000K	250mA, 58V
43129	Bianco/White	10W	600	60°	5000K	250mA, 58V
43133	Antracite Anthracite	10W	600	60°	5000K	250mA, 58V

INSTALLAZIONE
APPLICATION

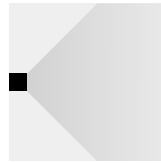

Parete/Wall

DISEGNI TECNICI
TECHNICAL DRAWINGS

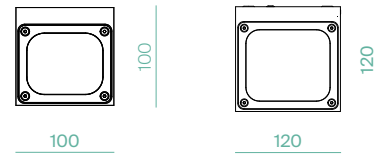

43126
43127
43130
43131

43128
43129
43132
43133



TITANO EVO
PARETE
BI-EMISSIONE

LED
CRI >80
PF 0.57 (2x6W)
0.92 (2x10W)

CODE	FINISHING	WATT	LUMEN	BEAM	KELVIN	DRIVER
43134	Bianco / White	2x6W	800	45°	3000K	500mA, 24V 30V
43138	Antracite / Anthracite	2x6W	800	45°	3000K	500mA, 24V 30V
43135	Bianco / White	2x6W	800	45°	5000K	500mA, 24V 30V
43139	Antracite / Anthracite	2x6W	800	45°	5000K	500mA, 24V 30V
43136	Bianco / White	2x10W	1200	60°	3000K	250mA, 98V
43140	Antracite / Anthracite	2x10W	1200	60°	3000K	250mA, 98V
43137	Bianco/White	2x10W	1200	60°	5000K	250mA, 98V
43143	Antracite/ Anthracite	2x10W	1200	60°	5000K	250mA, 98V

INSTALLAZIONE
APPLICATION



Parete/Wall

DISEGNI TECNICI
TECHNICAL DRAWINGS

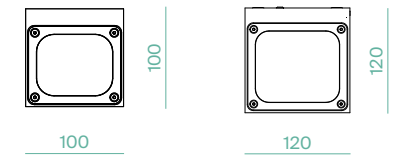

43134
43135
43138
43139

43136
43137
43140
43143



TITANO EVO PALO

Corpo luminoso non incluso
Lighting source not included

CODE	FINISHING	DESCRIPTION	MEASUREMENTS
40580	Antracite/ Anthracite	Accessorio c/griglie antiabbagliamento/ Accessory with anti-glaring grid	120x580
40579	Antracite/ Anthracite	Accessorio c/griglie antiabbagliamento/ Accessory with anti-glaring grid	100x500

INSTALLAZIONE APPLICATION

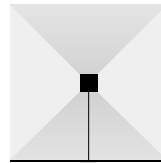

Terra/Floor

DISEGNI TECNICI TECHNICAL DRAWINGS

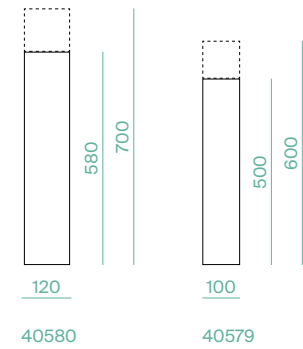

TITANO EVO SOFFITTO

LED
CRI
PF
Edison
>80
0.54 (6W)
0.91 (10W)

CODE	FINISHING	WATT	LUMEN	BEAM	KELVIN	DRIVER
43144	Bianco/White	6W	400	45°	3000K	500mA, 23V
43148	Antracite/ Anthracite	6W	400	45°	3000K	500mA, 23V
43145	Bianco/White	6W	400	45°	5000K	500mA, 23V
43149	Antracite/ Anthracite	6W	400	45°	5000K	500mA, 23V
43146	Bianco/White	10W	600	60°	3000K	250mA, 58V
43150	Antracite/ Anthracite	10W	600	60°	3000K	250mA, 58V
43147	Bianco/White	10W	600	60°	5000K	250mA, 58V
43151	Antracite/ Anthracite	10W	600	60°	5000K	250mA, 58V

INSTALLAZIONE APPLICATION



Soffitto/Ceiling

DISEGNI TECNICI TECHNICAL DRAWINGS

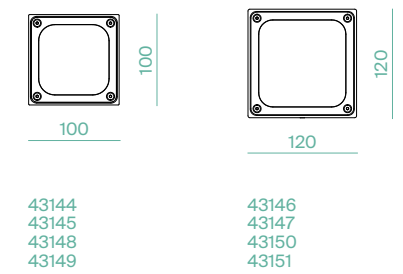



MOONLIGHT

Apparecchio a parete e terra LED integrato
in alluminio estruso
Driver integrato

Built-in LED wall-bracket and floor
in extruded aluminium
Built-in driver

MOONLIGHT PALO

LED RF2835
CRI 80
PF 0.9



CODE	FINISHING	WATT	LUMEN	BEAM	KELVIN	DRIVER
41167	Antracite/ Anthracite	10W	700	90°	3000K	250VDC/32mA
41168	Antracite/ Anthracite	15W	1050	90°	3000K	250VDC/48mA
41169	Antracite/ Anthracite	20W	1400	100°	3000K	250VDC/64mA

INSTALLAZIONE APPLICATION



Terra/Floor

DISEGNI TECNICI TECHNICAL DRAWINGS

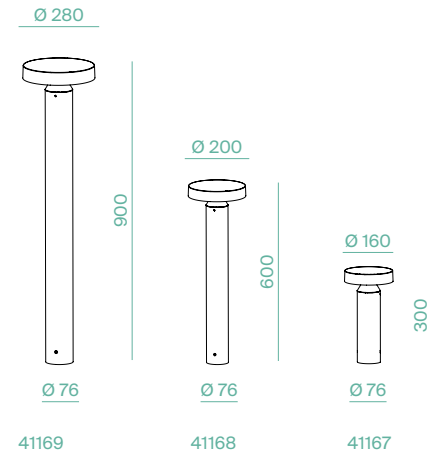

MOONLIGHT PARETE

LED RF2835
CRI 80
PF 0.9

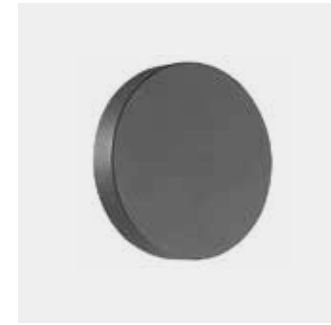

CODE	FINISHING	WATT	LUMEN	BEAM	KELVIN	DRIVER
41166	Antracite/ Anthracite	15W	1050	90°	3000K	250VDC/48mA

INSTALLAZIONE APPLICATION

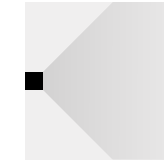

Parete/Wall

DISEGNI TECNICI TECHNICAL DRAWINGS

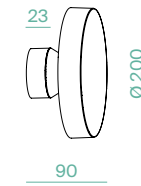

ACCESSORI ACCESSORIES



CODE	DESCRIPTION
11554	Distanziale per parete/ Wall mounting spacer





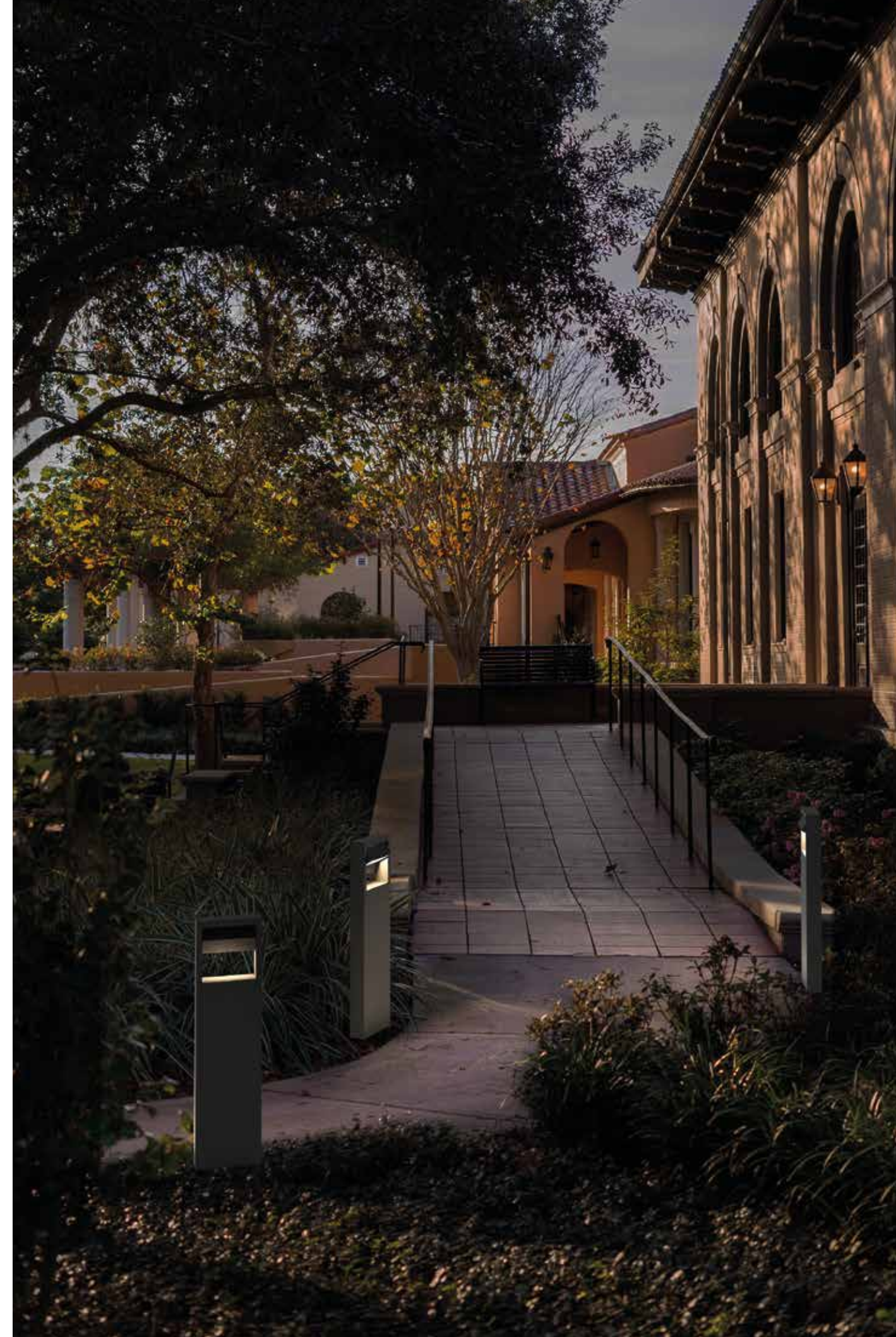

FOS

Apparecchio a parete e terra
LED integrato orientabile in alluminio estruso
Driver integrato

Built-in LED wall-bracket and floor adjustable
in extruded aluminium
Built-in driver

FOS PALO

LED RF2835
CRI 80
PF 0.9

CODE	FINISHING	WATT	LUMEN	BEAM	KELVIN	DRIVER
41165	Antracite/ Anthracite	8W	560	120°	3000K	250VDC/48mA

INSTALLAZIONE APPLICATION



Terra/Floor

DISEGNI TECNICI TECHNICAL DRAWINGS

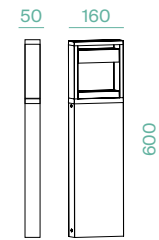

REGOLAZIONI ADJUSTABILITY



FOS PARETE

LED RF2835
CRI 80
PF 0.9

CODE	FINISHING	WATT	LUMEN	BEAM	KELVIN	DRIVER
41164	Antracite/ Anthracite	8W	560	120°	3000K	250VDC/25mA

INSTALLAZIONE APPLICATION

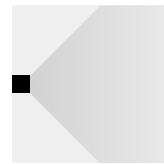

Parete/Wall

DISEGNI TECNICI TECHNICAL DRAWINGS

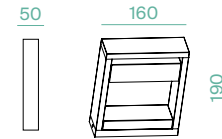

REGOLAZIONI ADJUSTABILITY





COMBI EVO

Apparecchio a parete bi-emissione
Corpo in alluminio pressofuso
Optica regolabile
Driver integrato

Built-in LED wall-bracket
Double-sided emission
Die-cast aluminium body
Adjustable beam
Built-in driver

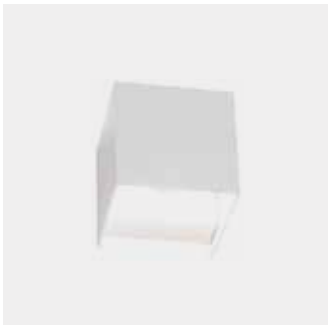

COMBI EVO

LED
CRI >80
PF >0.5

Bridgelux

CODE	FINISHING	WATT	LUMEN	BEAM	KELVIN	DRIVER
43168	Bianco/White	5W+5W	890	0-100°	3000K	300mA 100-240V
43169	Nero/Black	5W+5W	890	0-100°	3000K	300mA 100-240V

INSTALLAZIONE APPLICATION



Parete/Wall

DISEGNI TECNICI TECHNICAL DRAWINGS

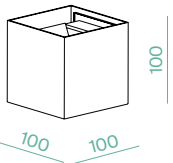

REGOLAZIONI ADJUSTABILITY

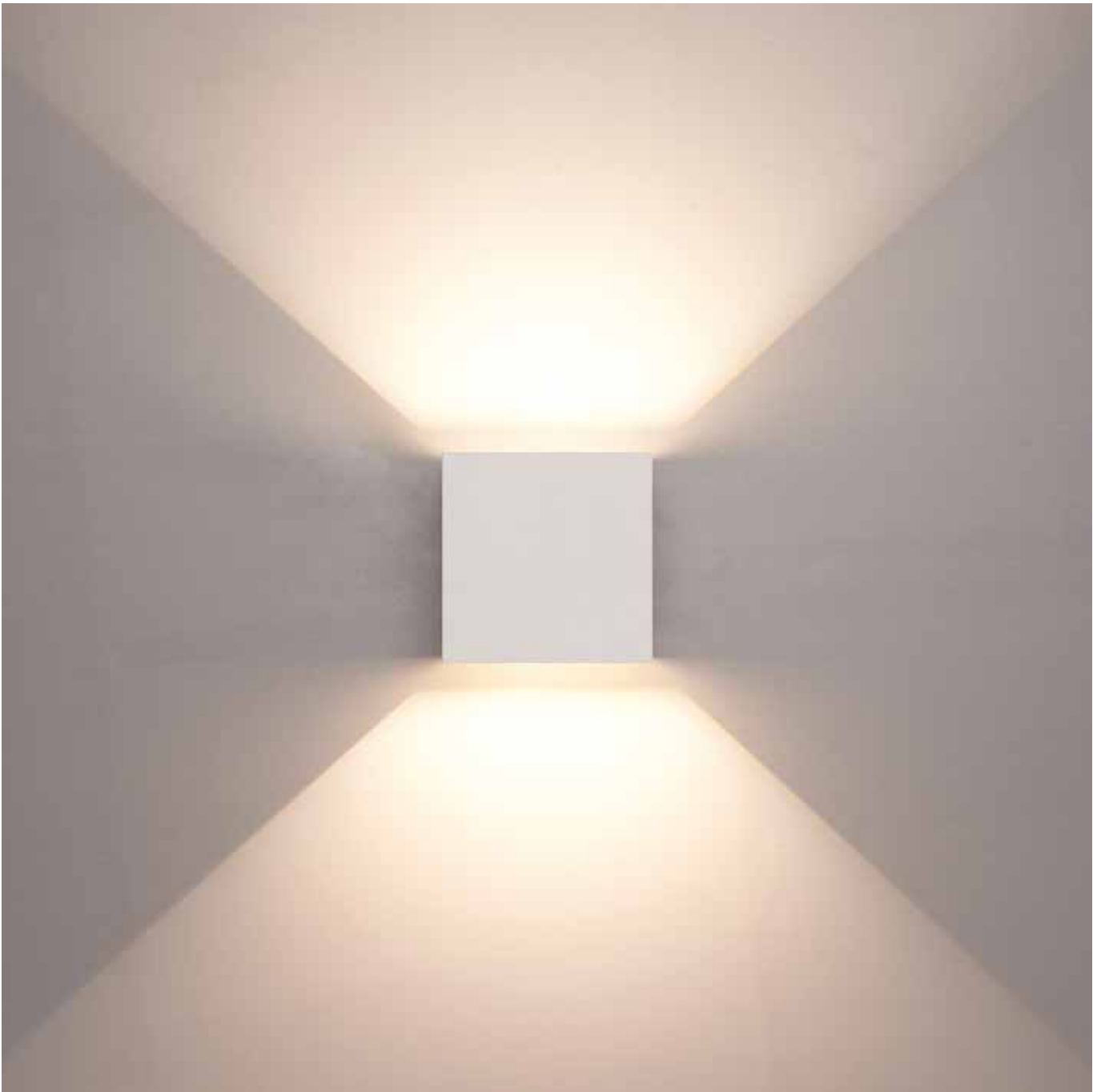

5 GARANZIA WARRANTY LED IP65 230V 50/60Hz CE

ACCENTO

LED
CRI >80
PF 0.94

Edison
>80
0.94



CODE	FINISHING	WATT	LUMEN	BEAM	KELVIN	DRIVER
43156	Antracite / Anthracite	30W	2800	90°	3000K	700mA 62V
43157	Antracite / Anthracite	30W	2800	90°	5000K	700mA 62V
43158	Bianco / White	30W	2800	90°	3000K	700mA 62V
43159	Bianco / White	30W	2800	90°	5000K	700mA 62V



INSTALLAZIONE APPLICATION



Parete/Wall

DISEGNI TECNICI TECHNICAL DRAWINGS

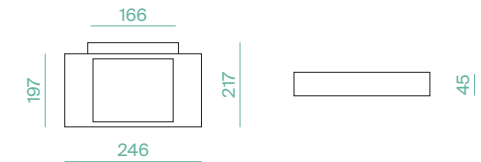

ACCENTO

Apparecchio a parete led integrato mono-emissione
Corpo in alluminio pressofuso verniciato
e ottica brillantata

One-side emission built-in LED wall-bracket
Painted die-cast aluminium body
with multi-faceted reflector



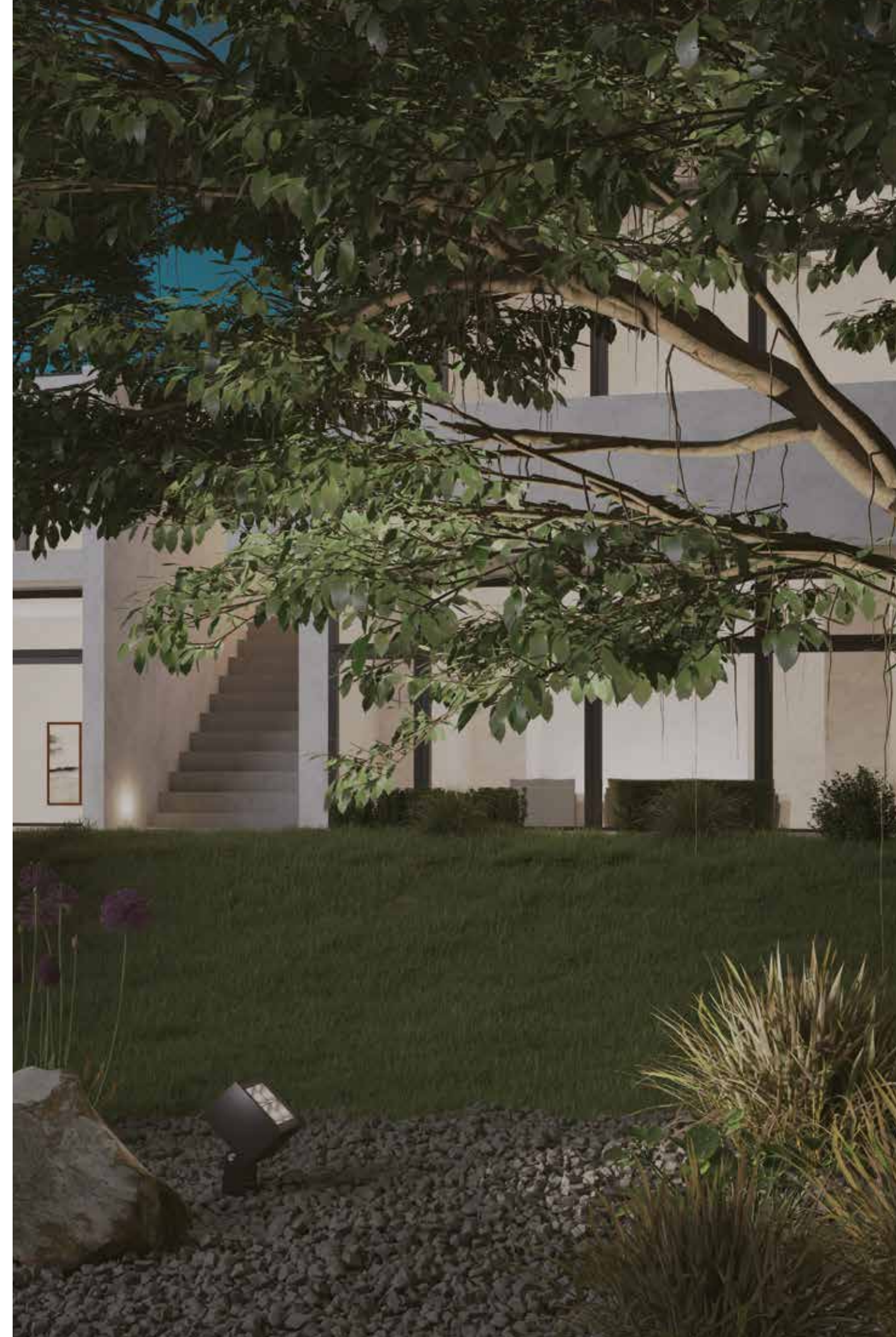

DARDO

Proiettore LED integrato orientabile
Corpo in alluminio pressofuso verniciato
Driver integrato
Dispositivo anticondensa

Adjustable built-in LED projector
Painted die-cast aluminium body
Built-in driver
Equipped with anti-condensation device



DARDO

LED OSRAM
 CRI >80
 PF 0.52

CODE	FINISHING	WATT	LUMEN	BEAM	KELVIN
42790	Antracite/ Anthracite	6W	550	30°	3000K

**INSTALLAZIONE
APPLICATION**



Terra/Floor

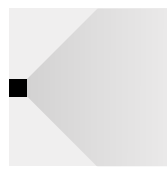

Parete/Wall

**DISEGNI TECNICI
TECHNICAL DRAWINGS**

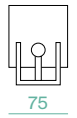
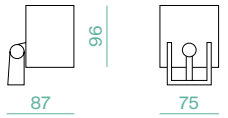

**REGOLAZIONI
ADJUSTABILITY**



5 ANNI GARANZIA WARRANTY
 LED
 IP65 IK07
 CE

**ACCESSORI
ACCESSORIES**

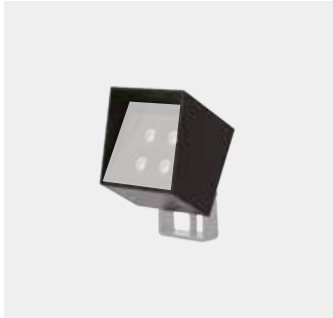

42791



42792

CODE	DESCRIPTION
42791	Accessorio anti-glare/Anti-glare accessory
42792	Accessorio picchetto in plastica/Plastic spike accessory

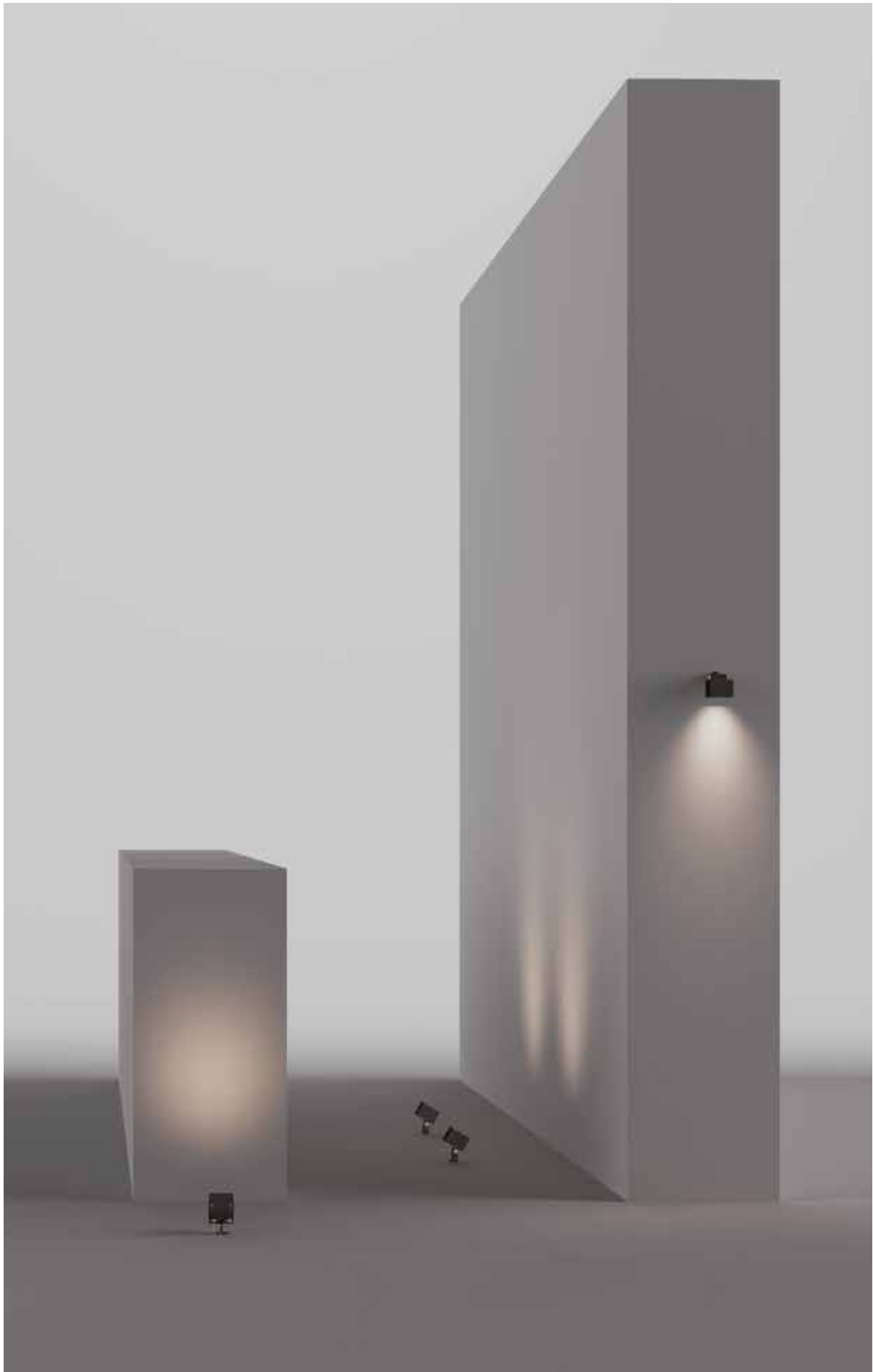

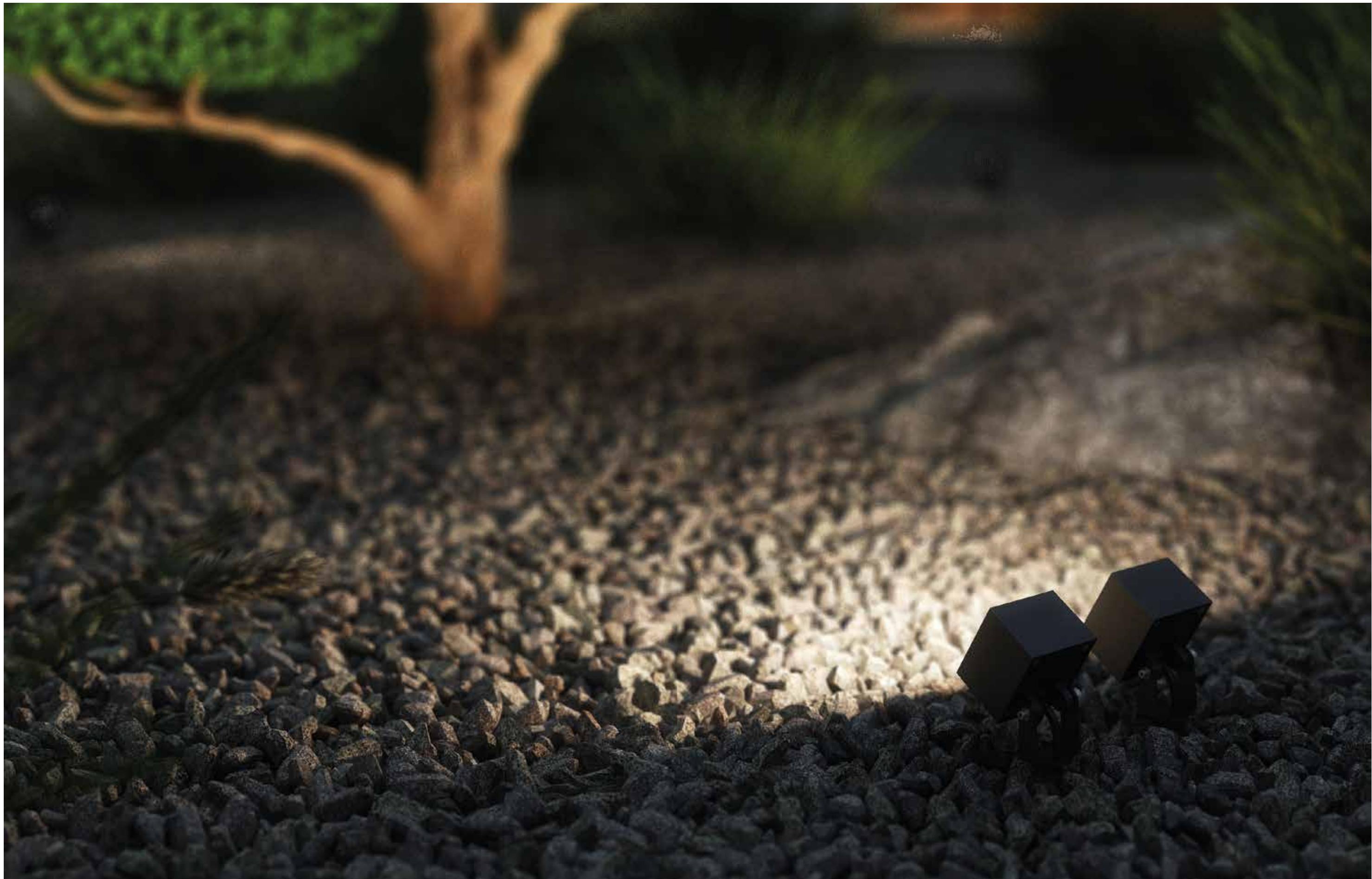



SCORPIO

Incasso calpestabile LED integrato
Corpo in alluminio anodizzato
Anello inox AISI 316
Vetro temperato trasparente
Cassaforma in PVC
Driver integrato

Walk-over recessed fitting with built-in LED
Anodized aluminium body
AISI 316 stainless steel ring
Transparent tempered glass
PVC frame-work
Built-in driver





SCORPIO XS

LED
CRI >80
PF 0.5

COB Edison
>80
0.5

CODE	FINISHING	WATT	LUMEN	BEAM	KELVIN
40260	Inox	3W	210	25°	3000K
40261	Inox	3W	230	25°	5000K

INSTALLAZIONE APPLICATION



Calpestabile/
Walk-Over

DISEGNI TECNICI TECHNICAL DRAWINGS

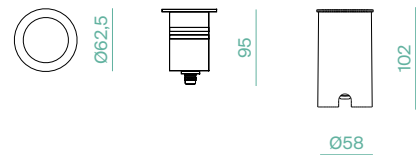

Ø58
Framework



SCORPIO S

LED
CRI >80
PF 0.5

COB Edison
>80
0.5

CODE	FINISHING	WATT	LUMEN	BEAM	KELVIN
40248	Inox	4,5W	300	35°	3000K
40249	Inox	4,5W	350	35°	5000K

INSTALLAZIONE APPLICATION



Calpestabile/
Walk-Over

DISEGNI TECNICI TECHNICAL DRAWINGS

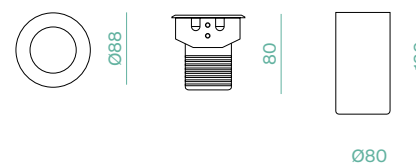

Ø80
Framework

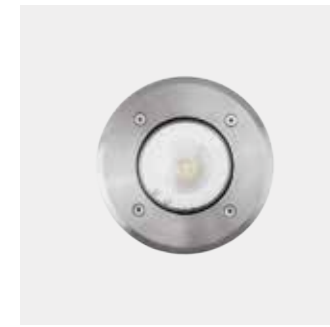

SCORPIO L

LED
CRI >80
PF 0.7

COB Edison
>80
0.7

CODE	FINISHING	WATT	LUMEN	BEAM	KELVIN
40250	Inox	10W	900	35°	3000K
40251	Inox	10W	950	35°	5000K

INSTALLAZIONE APPLICATION



Calpestabile/
Walk-Over

DISEGNI TECNICI TECHNICAL DRAWINGS

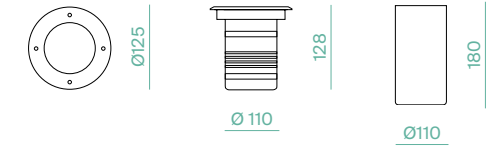

Ø110
Framework



ACCESSORI ACCESSORIES



40015

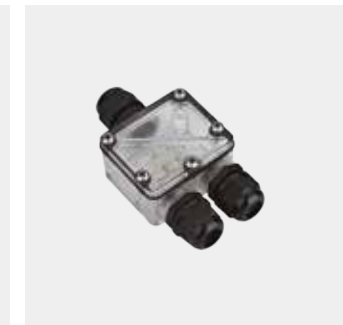

40016

CODE	DESCRIPTION
40015	connettore IP67 1 via
40016	connettore IP67 2 vie

DRIVER

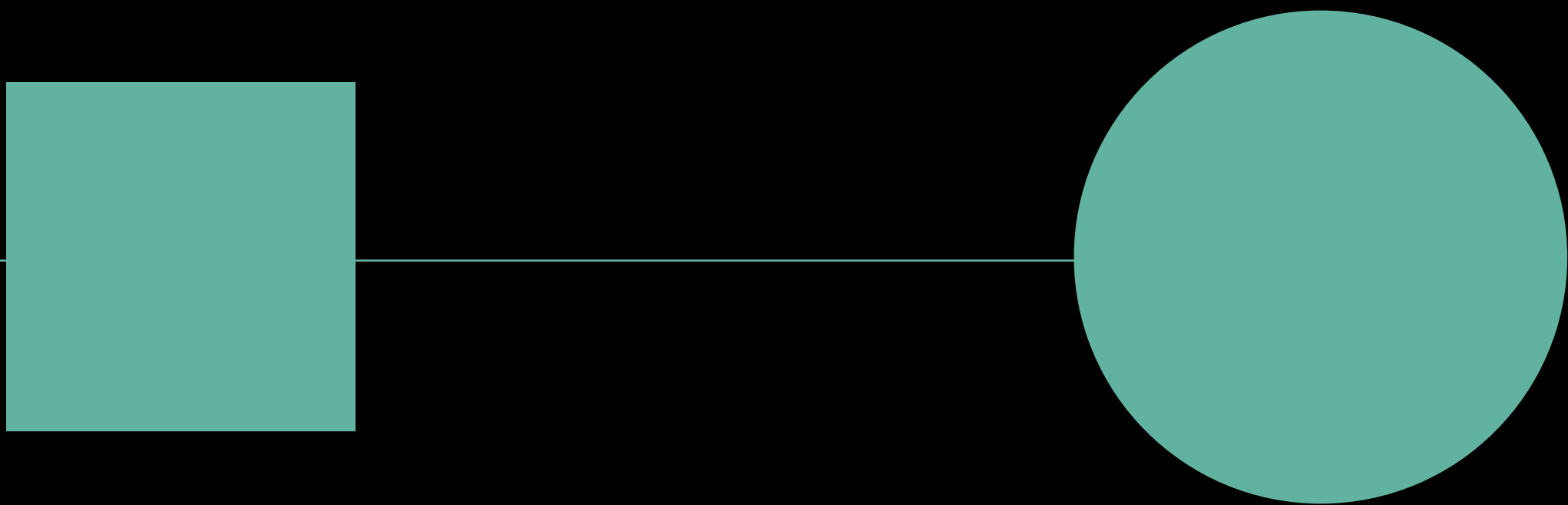

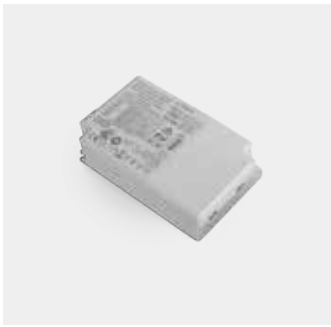

DRIVER

42683 - 42684 - 40314

CODE	VOLTAGE	CURRENT	MODEL	SIZE	MODE
42683	220-240 12-42V	650-1100mA	ONE4ALL	125x76x30mm	DALI, PUSH, 1-10V
42684	220-240 12-42V	250-600mA	ONE4ALL	125x76x30mm	DALI, PUSH, 1-10V
40314	110-277V 14-42V	400-1100mA	n/a	115x52x30mm	1-10V

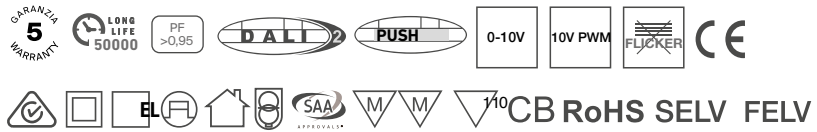

NOTE NOTES

INDICE ANALITICO

- A 310 ACCENTO
- 194 ALTAIR
- 142 AQUA_COB
- 144 AQUA_SMD
- 238 AURORA
- B 128 BILUCE
- 118 BLITZ
- 246 BLOC
- 213 BOX AR111
- 212 BOX DICRO
- C 26 CLARA
- 306 COMBI EVO
- 204 CONTAINER
- 208 CONTAINER 111
- 200 CYL
- 220 CYL SOSP
- D 312 DARDO
- 167 DEEP
- 169 DEEP 111
- 168 DEEP 111 ZERO
- 165 DEEP C/VETRO
- 166 DEEP ZERO
- 86 DEEP_EVO
- 94 DEEP_EVO LESS
- 98 DEEP_EVO STD
- 180 DIOGENE
- 176 DIOGENE HYBRID
- 266 DOUBLE
- 324 DRIVER
- 242 DUMBO
- E 83 EMERGENZA
- F 302 FOS
- 146 FRAME
- 149 FRAME 111
- 152 FRAMELESS
- 155 FRAMELESS 111
- 50 FULGOR
- 100 FULGOR_IN
- G 104 GYMBO QUADRO
- 108 GYMBO TONDO
- H 118 HYPER DICRO
- K 32 KLIK KLAK
- L 262 LINE DEEP INCASSO
- 264 LINE INCASSO
- 258 LINE_EVO
- M 132 MINI
- 230 MINIMA
- 296 MOONLIGHT
- O 116 OCCHIO
- 254 ONDA INCASSO
- 68 ORBIT BINARIO
- 216 ORBIT SOFFITTO/PARETE
- P 268 PR1
- 268 PR1_DEEP
- 272 PR2 INCASSO
- 272 PR2_DEEP INCASSO
- 276 PR3_EVO
- 280 PR4
- 110 PUNTO
- R 122 RADIANTE
- S 318 SCORPIO
- 224 SHANGHAI
- 22 STREAMLIGHT
- 12 STREAMLIGHT SYSTEM
- T 288 TITANO EVO
- 78 TRACKS
- 79 TRACKS INCASSO
- 70 TRACK_COVER
- 188 TWIGGY_LESS
- U 64 UNICO AR111
- 54 UNICO COMPACT
- 60 UNICO DICRO BINARIO
- 214 UNICO DICRO SOFFITTO/PARETE
- W 252 WALL INCASSO
- 158 WIZARD
- Z 140 ZEUS

LOGICA È UN MARCHIO DI MARINO CRISTAL S.P.A.

Marino Cristal S.p.A.
Via Guardia del Consiglio, 29
47899 Serravalle
Rep. di San Marino

Tel. (+378) 0549 901188
Fax (+378) 0549 900612

www.logicailluminazione.com
info@logicailluminazione.com

Project
Giulia Galassi
Gazmend Zeneli

Print
Pazzini Editore

